

Panasonic[®]

Operating Instructions Digital Camera

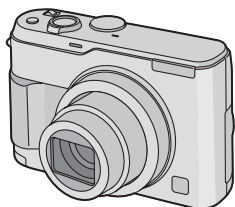

Model No. **DMC-LZ2PP**
DMC-LZ1PP

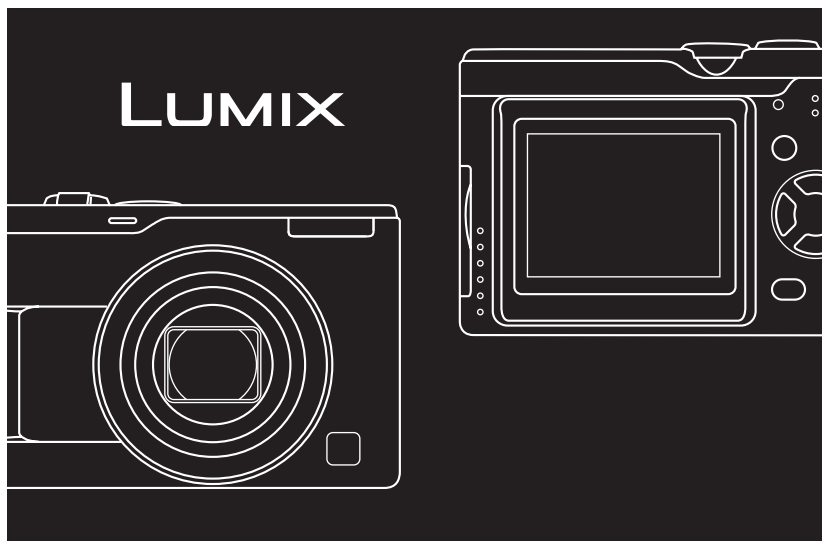

Before connecting, operating or
adjusting this product, please read
the instructions completely.

For USA assistance, please call: 1-800-272-7033 or send e-mail to : digitalstillcam@panasonic.com

For Canadian assistance, please call: 1-800-561-5505 or visit us at www.panasonic.ca

VQT0P65

Dear Customer,

We would like to take this opportunity to thank you for purchasing this Panasonic Digital Camera. Please read these Operating Instructions carefully and keep them handy for future reference.

Information for Your Safety

WARNING

TO REDUCE THE RISK OF FIRE OR SHOCK HAZARD AND ANNOYING INTERFERENCE, USE ONLY THE RECOMMENDED ACCESSORIES AND DO NOT EXPOSE THIS EQUIPMENT TO RAIN OR MOISTURE. DO NOT REMOVE THE COVER (OR BACK); THERE ARE NO USER SERVICEABLE PARTS INSIDE. REFER SERVICING TO QUALIFIED SERVICE PERSONNEL.

U.S.A. CONSUMERS ONLY

Notice:

This product has parts that contain a small amount of mercury. It also contains lead in some components. Disposal of these materials may be regulated in your community due to environmental considerations. For disposal or recycling information please contact your local authorities, or the Electronics Industries Alliance:
<<http://www.eiae.org>.>

Carefully observe copyright laws.

Recording of pre-recorded tapes or discs or other published or broadcast material for purposes other than your own private use may infringe copyright laws. Even for the purpose of private use, recording of certain material may be restricted.

- Please note that the actual controls and components, menu items, etc. of your Digital Camera may look somewhat different from those shown in the illustrations in these Operating Instructions.
- SD Logo is a trademark.
- Other names, company names, and product names printed in these instructions are trademarks or registered trademarks of the companies concerned.

THE SOCKET OUTLET SHALL BE INSTALLED NEAR THE EQUIPMENT AND SHALL BE EASILY ACCESSIBLE.

CAUTION

Danger of explosion if battery is incorrectly replaced. Replace only with the same or equivalent type recommended by the manufacturer. Dispose of used batteries according to the manufacturer's instructions.

FCC Note: (U.S. only)

This equipment has been tested and found to comply with the limits for a Class B digital device, pursuant to Part 15 of the FCC Rules. These limits are designed to provide reasonable protection against harmful interference in a residential installation. This equipment generates, uses, and can radiate radio frequency energy and, if not installed and used in accordance with the instructions, may cause harmful interference to radio communications. However, there is no guarantee that interference will not occur in a particular installation. If this equipment does cause harmful interference to radio or television reception, which can be determined by turning the equipment off and on, the user is encouraged to try to correct the interference by one or more of the following measures:

- Reorient or relocate the receiving antenna.
- Increase the separation between the equipment and receiver.
- Connect the equipment into an outlet on a circuit different from that to which the receiver is connected.
- Consult the dealer or an experienced radio/TV technician for help.

FCC Caution: To assure continued compliance, follow the attached installation instructions and use only shielded interface cables with ferrite core when connecting to computer or peripheral devices.

Any changes or modifications not expressly approved by the party responsible for compliance could void the user's authority to operate this equipment.

Trade Name: Panasonic
 Model No.: DMC-LZ2
 DMC-LZ1
 Responsible party: Panasonic Corporation of North America
 One Panasonic Way, Secaucus, NJ 07094
 Support Contact: Panasonic Consumer Electronics Company
 1-800-272-7033

This device complies with Part 15 of the FCC Rules. Operation is subject to the following two conditions: (1) This device may not cause harmful interference, and (2) this device must accept any interference received, including interference that may cause undesired operation.

This Class B digital apparatus complies with Canadian ICES-003

FC Panasonic
DMC-LZ2

FC Panasonic
DMC-LZ1

■ Care for the camera

- **Do not shake or cause impact to the camera.** The camera may not be operated normally or recording of pictures may be disabled, or the lens may be damaged.
- **Sand or dust may cause a malfunction of the camera. When you use the camera on a beach etc., take care so that sand or dust does not get into the camera.**
- When you use the camera on a rainy day or on a beach, take care so that water does not get into the camera.
- **If seawater splashes onto the camera, wet a soft cloth with tap water, wring it well, and use it to wipe the camera body carefully. Then, wipe it again with a dry cloth.**

■ About the LCD monitor

- **Do not press the LCD monitor strongly. It may cause uneven colors on the LCD monitor or a malfunction of the LCD monitor.**
- In a place with drastic temperature changes, condensation may form on the LCD monitor. Wipe it with a soft, dry cloth.
- If the camera is extremely cold when you turn the camera on, the image on the LCD monitor is slightly darker than usual at first. However, as the internal temperature increases, it goes back to the normal brightness.

Extremely high precision technology is employed to produce the LCD monitor screen. The result is more than 99.99% effective pixels with a mere 0.01% of the pixels inactive or always lit. However, this will not be recorded on the pictures in the built-in memory or the card.

■ About the Lens

- Do not direct the lens to the sun or strong light sources. It may cause not only a malfunction of the camera but irreversible damage to your eye.
- Do not press the lens strongly.
- Leaving the camera with the lens facing the sun may cause a malfunction. Be careful when you put the camera outside or near a window.

■ About Condensation (When the lens is fogged up)

Condensation takes place when the ambient temperature or humidity is changed as follows:

Be careful of condensation since it causes stains on the lens, fungus or malfunction.

- When the camera is brought inside from the cold to a warm room.
- When the camera is moved from outside to an air-conditioned car.
- When cool wind from an air conditioner or other is directly blown onto the camera.
- In humid places

Put the camera into plastic bag until the temperature of the camera is close to the ambient temperature to avoid condensation. In case of condensation, turn the camera off and then leave it for about 2 hours.

When the camera becomes close to the ambient temperature, the fog disappears naturally.

■ **If you will not be using the camera for a long time**

- Store the batteries in a cool and dry place with a relatively stable temperature. (Recommended temperature: 59°F – 77°F (15°C – 25°C), Recommended humidity: 40% – 60%)
- Be sure to remove the batteries and the card from the camera.
- When the batteries are left inserted in the camera, the batteries are discharged since a weak electric current is passed even if the camera is turned off. (Refer to P15 for Ni-MH batteries.)
- When you keep the camera in a closet or a cabinet, we recommend storing it with the desiccant (silica gel).

About These Operating Instructions

Please note that the description on this page is a sample and all pages are not described in this manner.

Compensating the Exposure

1



Use this function when you cannot achieve appropriate exposure due to the difference of brightness between the subject and the background.

2



- EV is an abbreviation of Exposure Value, and it is the amount of light given to the CCD by the aperture value and the shutter speed.

1



Modes indicated here allow you to use the functions or settings described on this page. Set the Mode dial to any of the modes to use the functions or settings.

2

Convenient or helpful information for use of the camera is described.

■ About illustrations in these operating instructions

Please note that the appearance of the product, the illustration or the menu screen are a little different from those in actual use.

The procedure is described for DMC-LZ2 as an example.

■ About illustrations of the cursor button

In these operating instructions, the operations on the cursor button are described as illustrated below.

e.g.: When you press the ▼ button

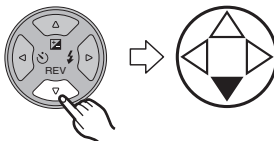

Contents

Before Use

Information for Your Safety	2
About These Operating Instructions	6

Preparation

Standard Accessories	9
Names of the Components	10
Quick Guide	12
About the Batteries	13
Inserting/Removing the Batteries.....	18
Inserting/Removing the Card (Optional)	19
About the Built-in Memory/the Card.....	20
Approximate number of recordable pictures and the size	22
Setting Date/Time (Clock Set)	23
About the Setup Menu.....	24
About the LCD Monitor	28

Recording pictures (basic)

Taking Pictures	30
Taking Pictures in Simple Mode	35
Checking the Recorded Picture (Review).....	38
Using the Optical Zoom	39
Taking Pictures using the Built-in Flash.....	40
Taking Pictures with the Self-timer	43
Compensating the Exposure	44
Taking Pictures using Auto Bracket.....	45
Optical Image Stabilizer.....	46
Taking Pictures using Burst Mode	47

Playback (basic)

Playing Back Pictures	49
9 Pictures Multi Playback.....	50
Using the Playback Zoom.....	51
Deleting Pictures.....	52

Recording pictures (advanced)

Using the Mode Dial	54
• Economy mode.....	54
• Macro mode.....	54
• Motion image mode	55
• Scene mode.....	57
– Portrait mode.....	58
– Sports mode	58
– Scenery mode	59
– Night scenery mode.....	59
– Night portrait mode	60
– Fireworks mode	60
– Party mode	61
– Snow mode.....	61

Recording Menu Settings

Using the [REC] mode menu	62
• White Balance [W.BALANCE]	63
• ISO Sensitivity [SENSITIVITY]	65
• Picture Size [PICT.SIZE]	65
• Quality [QUALITY]	66
• Audio Recording [AUDIO REC.] (DMC-LZ2 only)	66
• AF Mode [AF MODE].....	67
• Slow Shutter [SLOW SHUTTER].....	68
• Digital Zoom [D.ZOOM]	68
• Color Effect [COL.EFFECT].....	69
• Picture Adjustment [PICT.ADJ.].....	69

Playback (advanced)

Playing Back Pictures with Audio/ Motion Images.....	70
Using the [PLAY] mode menu	71
• Displaying pictures in a direction at the time of recording [ROTATE DISP.]	72
• Rotating the Picture [ROTATE]	72
• Setting the Picture to be Printed and the Number of Prints [DPOF PRINT].....	73
• Preventing Accidental Erasure of the Picture [PROTECT]	75
• Playing Back with Slide Show [SLIDE SHOW].....	76
• Adding Audio to Recorded Pictures [AUDIO DUB.] (DMC-LZ2 only)	77
• Resizing the Pictures [RESIZE].....	78
• Trimming the Pictures [TRIMMING]	79
• Copying Picture Data [COPY]	81
• Initializing the Built-in Memory/ the Card [FORMAT]	82
Playing Back Pictures on a TV Screen...	84

Connecting to a PC or Printer

Before Connecting to the PC or the Printer [USB MODE]	85
Connecting to a PC.....	86
Connecting to a PictBridge-compliant Printer.....	88

Others

Screen Display.....	92
Cautions for Use	95
Message Display	97
Troubleshooting	99
Specifications.....	102
Digital Camera Accessory System	104
Digital Camera Accessory Order Form (For USA Customers).....	105
Request for Service Notice (For USA Only).....	106
Limited Warranty (For USA Only)	107
Customer Services Directory (For USA Only).....	109
Index	110
Spanish Quick Use Guide/ Guía rápida en español.....	112

Standard Accessories

Before using your camera, check the contents.

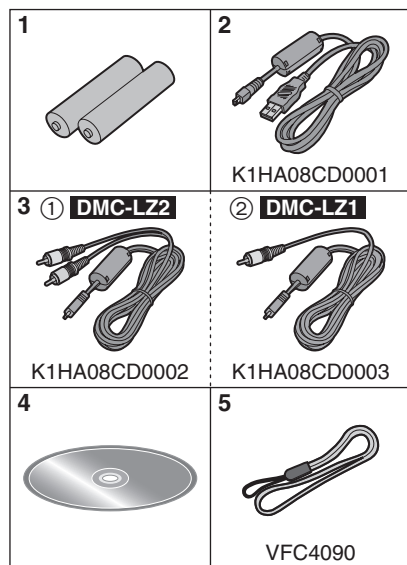

- 1 Batteries
AA Oxyride batteries (ZR6)
- 2 USB Connection Cable
- 3 ①: AV Cable
(Supplied with DMC-LZ2 only)
- ②: Video Cable
(Supplied with DMC-LZ1 only)

- 4 CD-ROM
- 5 Strap

• SD Memory Card is optional.

When you do not use the card, you can record or play back pictures on the built-in memory. (P20)

• If any of the accessories are lost, please contact Panasonic's parts department at 1 800 833-9626 (For USA) or in Canada call 1 800 561-5505 for more details on how to obtain replacement parts.

Names of the Components

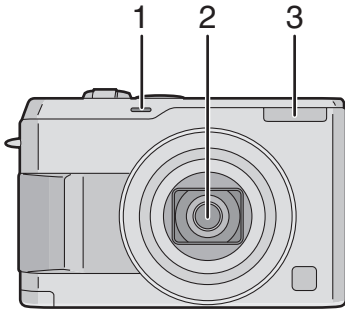

- 1 Self-timer Indicator (P43)
- 2 Lens (P4)
- 3 Flash (P40)

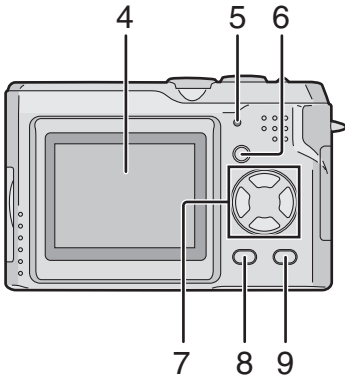

- 4 LCD Monitor (P28, 92)
- 5 Status Indicator (P14, 18, 54)
- 6 [DISPLAY] Button (P28)
- 7 Cursor Buttons
 - ◀/Self-timer Button (P43)
 - ▼/[REV] Button (P38)
 - ▶/Flash Setting Button (P40)
 - ▲/Exposure Compensation (P44)/Auto Bracket (P45)/White Balance Fine Adjustment (P64)/Backlight Compensation in Simple Mode (P37) Button
- 8 [MENU] Button (P24)
- 9 Single or Burst Mode (P47)/Delete (P52) Button

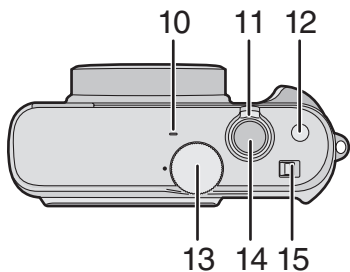

- 10 Microphone (DMC-LZ2 only) (P55, 66)
- 11 Zoom Lever (P39, 68)
- 12 Optical Image Stabilizer Button (P46)
- 13 Mode Dial (P30)
- 14 Shutter Button (P31)
- 15 Camera ON/OFF Switch (P12)

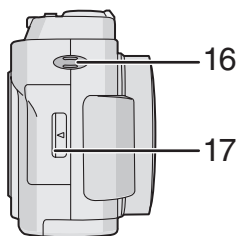

- 16 Strap Eyelet

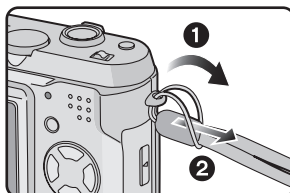

- 17 Card Door (P19)

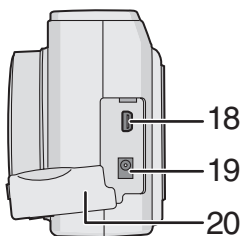

- 18 [DIGITAL/AV OUT] Socket (DMC-LZ2 only)
- [DIGITAL/V.OUT] Socket (DMC-LZ1 only) (P84, 86, 88)
- 19 [DC IN] Socket (P86, 88)
 - Please be sure to use genuine Panasonic AC adaptor (DMW-AC1; optional).
- 20 Terminal Door

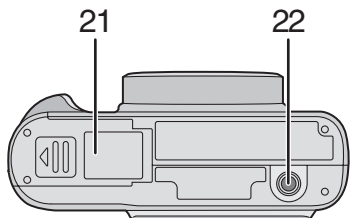

- 21 Battery Door (P18)
- 22 Tripod Receptacle
 - When you use a tripod, make sure the tripod is stable with the camera attached to it.

Quick Guide

This is the overview of the procedure to record and playback pictures with the camera. For each operation, be sure to refer to the corresponding pages.

1 Insert the batteries. (P13, 18)

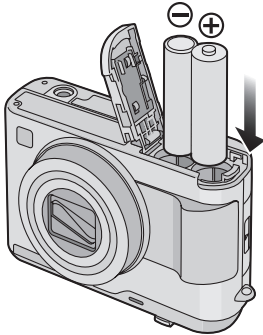

- When you do not use the card (optional), you can record or play back pictures on the built-in memory (P20). Refer to P19 when you use a card.

2 Turn the camera on to take pictures.

- Set the clock. (P23)
- Select the type of battery in use on [BATTERY TYPE] in the [SETUP] menu. (P24)

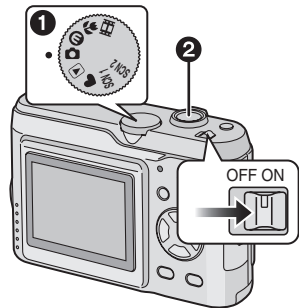

- 1 Set the mode dial to [📷].
- 2 Press the shutter button to take pictures. (P31)

3 Play back the pictures.

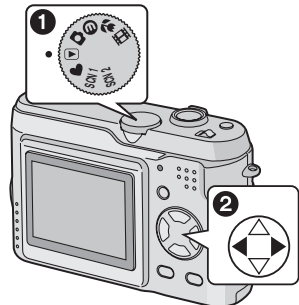

- 1 Set the mode dial to [▶].
- 2 Select the picture you want to view. (P49)

About the Batteries

■ Usable batteries

AA Oxyride batteries (supplied)*
AA Alkaline batteries (optional)
AA Rechargeable Ni-MH (nickel-metal hydride) batteries (optional)

*The oxyride battery is a new type of non-rechargeable battery developed by Panasonic.

Oxyride batteries have higher power and more stability to handle the higher load on the batteries, compared to conventional alkaline batteries.

Oxyride batteries are specially designed to use with products as digital still cameras, that place more load on the batteries.

- **It is necessary to select the type of batteries according to the batteries you use. Select the type of batteries in use on [BATTERY TYPE] in the [SETUP] menu (P24). The setting can be distinguished by the color of the battery indication (blue or white).**

– The battery indication does not appear when you use the camera along with the AC adaptor (DMW-AC1; optional).

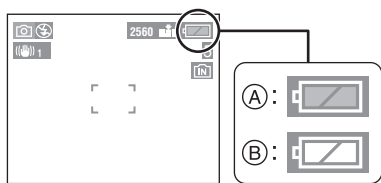

- (A): When oxyride batteries are selected**
The battery indication turns blue.
- (B): When alkaline/Ni-MH batteries are selected**
The battery indication turns white.

- We recommend that you use Panasonic batteries.
- The performance of the batteries may vary depending on brand or storage terms/condition of the batteries.
- The performance of the batteries may be temporarily deteriorated in low temperature conditions [50°F (10°C) or less]. However, the performance of the batteries is recovered when the batteries become close to the ambient temperature.
- Depending on the temperature or the conditions, the camera may not be operated properly or the battery indication may not be displayed correctly and the batteries may become empty without indication. However, this is not a malfunction.
- We recommend turning the camera off frequently while recording to maintain the power of the batteries for a long time. If you will be using the camera for a long time, using rechargeable Ni-MH batteries is more practical.
- The exhausted batteries may recover some performance when they are left for a period of time. However, they cannot be used for a long time. Be sure to replace with new batteries.



■ Unusable batteries

Manganese batteries	Lithium batteries
Nickel batteries	Ni-Cd batteries

- Operations by using the batteries listed above are not guaranteed. If the batteries listed above are used, leakages can result and the following malfunctions can occur;
 - Remaining battery power may not be displayed accurately.
 - The camera may not be turned on.
 - Data written to the built-in memory or the card can be damaged resulting in the loss of photos.

■ Shapes of batteries that cannot be used

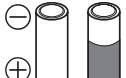
- Batteries with unusual shapes cause leakage, generation of heat or explosion if they are inserted in the camera.
- Some commercial batteries have partially or entirely peeled outer coverings. Never use these batteries. (Refer to the illustration below.)

<ul style="list-style-type: none"> • All or part of the seal of batteries are peeled off 	<ul style="list-style-type: none"> • ⊖ polarity is flat 
---	--

■ Battery indication

The remaining battery power appears on the screen. [It does not appear when you use the camera along with the AC adaptor (DMW-AC1; optional).]



- The battery indication turns red and blinks. (If the LCD monitor is turned off, the status indicator blinks.)
- Replace with new batteries or fully charged Ni-MH batteries.

■ Proper Care and Handling of the Batteries

If you mishandle the batteries, leakage, generation of heat and fire or explosion may occur. Observe the following cautions;

- Do not subject the batteries or the battery contacts to any moisture.
- Do not peel off or scratch the covered seal.
- Do not drop, hit or do anything that causes impact to the batteries.
- Do not use batteries that show signs of leakage, deformation, discoloration or other defects.
- Do not store batteries in high humidity or high temperature environments.
- Keep batteries away from children.
- When you replace batteries, always use two of the same type.
- If you will not be using the camera for a long time, remove the batteries.
- Batteries may become warm soon after you use the camera. To remove the batteries, turn the camera off and then wait until the battery temperature becomes lower.

- As the ambient temperature is low [50°F (10°C) or less], the performance of the batteries will be deteriorated and the available recording/playback time becomes extremely short. This is normal. Alkaline batteries significantly show such tendencies. In such cases, remove the batteries and warm them in your pocket. Take special care not to allow the contacts to come into contact with metal objects or a pocket warmer in your pocket.
- If an oil stain or any foreign substance is found on the battery contacts, it could prevent the batteries from making good electrical contact. The available recording/playback time may become extremely short. Before inserting the batteries, clean the battery contacts with soft, dry cloth.

If any leakage from the batteries is noted, remove the batteries, thoroughly wipe off the battery electrolyte in the battery housing and then insert new batteries or fully charged Ni-MH batteries.

If leaked battery electrolyte contacts your hand or cloth, wash with water. Battery electrolyte may cause loss of sight if it comes in contact with your eyes. In such cases, do not rub at your eyes. Immediately wash your eyes with pure water and consult a doctor.

■ Ni-MH Batteries (Nickel Metal Hydride)

Ni-MH batteries can be used when you charge them with the exclusive charger. However, wrong handling of the batteries may cause leakage, generation of heat, fire or explosion. Please be aware of the following issues:

- If any oxidation or foreign substance is found on the battery contacts, the batteries may not be charged correctly. Clean battery contacts and terminals of the recharger with a soft, dry cloth.
- Newly purchased Ni-MH batteries or those which have not been used for a long period of time may not reach full capacity after one charge. This is a feature of the batteries, not a malfunction. The overall performance will increase after repeating discharge/charge cycles several times.
- Batteries should be used to the point when the camera stops working before recharging. If you charge batteries without discharging enough, it can cause “memory effect”, whereby the overall operating time can be decreased.
- If “memory effect” occur, use the batteries until the camera stops working and then recharge them fully. Repeat the discharge/charge cycles several times. The capacity of the batteries will be recovered.
- Ni-MH batteries will naturally discharge and the capacity will become lower even if they are not in use.
- Once Ni-MH batteries have reached full charge, do not charge them continuously.
- Do not peel off or scratch the covered seal.
- Read the operating instructions for the battery charger.

Ni-MH batteries have a limited life. The capacity of the batteries decreases gradually over time. If available time seems much shorter, the battery life may be expired. Purchase new batteries.

- The battery life differs depending on the condition stored or used or environment.

When you do not use batteries for a long period of time

- When the batteries are left inserted in the camera, the batteries are discharged since a weak electric current is passed even if the camera is turned off. If you leave the batteries, they will excessively discharge and may become unusable even if they are recharged.
- When you store the batteries for a long period of time, we recommend charging the batteries once a year and removing them from the camera for storage after the batteries are completely discharged.

■ The battery life

The number of recordable pictures by CIPA standard (In normal picture mode)

- CIPA is an abbreviation of [Camera & Imaging Products Association].

Batteries Used	Number of recordable pictures
Panasonic Oxyride batteries (supplied or optional)	DMC-LZ2: Approx. 235 pictures (Approx. 117 min.)
	DMC-LZ1: Approx. 215 pictures (Approx. 107 min.)
Panasonic Alkaline batteries (optional)	DMC-LZ2: Approx. 150 pictures (Approx. 75 min.)
	DMC-LZ1: Approx. 140 pictures (Approx. 70 min.)
Fully charged Panasonic Ni-MH batteries (optional)	DMC-LZ2: Approx. 390 pictures (Approx. 195 min.)
	DMC-LZ1: Approx. 370 pictures (Approx. 185 min.)

Recording conditions by CIPA standard

- Temperature: 73.4°F (23°C)/
Humidity: 50% when LCD monitor is on.

- Using Panasonic's SD Memory Card (16 MB)*
 - Starting recording 30 seconds after the camera is turned on.
 - **Recording once every 30 seconds**, with full flash every other recording.
 - Rotating the zoom lever towards Tele to Wide and vice versa in every recording.
 - Turning the camera off every 10 recordings./Leaving the camera until the batteries are cooled down.
- *The card is not supplied.

The number of recordable pictures varies depending on the recording interval time.
If the recording interval time becomes longer, the number of recordable pictures decreases.
(e.g., when taking pictures every 2 minutes: about 1/4 of the amount when recording once every 30 seconds)

Recordable number in low temperatures (In normal picture mode)

(Temperature: 32°F (0°C)/Other recording conditions comply with CIPA standard)

Batteries Used	Number of recordable pictures
Panasonic Oxiride batteries (supplied or optional)	DMC-LZ2: Approx. 40 pictures (Approx. 20 min.)
	DMC-LZ1: Approx. 35 pictures (Approx. 17 min.)
Panasonic Alkaline batteries (optional)	DMC-LZ2: Approx. 35 pictures (Approx. 17 min.)
	DMC-LZ1: Approx. 30 pictures (Approx. 15 min.)
Fully charged Panasonic Ni-MH batteries (optional)	DMC-LZ2: Approx. 360 pictures (Approx. 180 min.)
	DMC-LZ1: Approx. 340 pictures (Approx. 170 min.)

- Please note that the performance of the oxiride batteries and the alkaline batteries significantly decreases in low temperature conditions.

Playback time

Batteries Used	Continuous playback time
Panasonic Oxiride batteries (supplied or optional)	DMC-LZ2: Approx. 410 min.
	DMC-LZ1: Approx. 400 min.
Panasonic Alkaline batteries (optional)	DMC-LZ2: Approx. 400 min.
	DMC-LZ1: Approx. 390 min.
Fully charged Panasonic Ni-MH batteries (optional)	DMC-LZ2: Approx. 490 min.
	DMC-LZ1: Approx. 470 min.



- Recordable number/playback time varies depending on the storage condition or use condition.
- Recordable number/playback time varies depending on the brand and the type of the batteries used.
- We recommend using the economy mode (P54) to maintain the battery power or turning the camera off frequently while recording.

Inserting/Removing the Batteries

- Check that the camera is turned off and that the lens is retracted.
- Use oxyride batteries (supplied), alkaline batteries (optional) or Ni-MH batteries (optional).

1 Slide the battery door to open it.

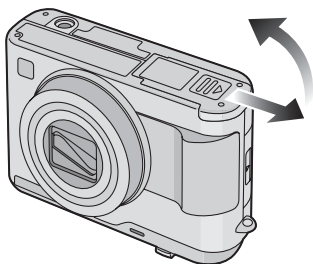

2 Insert the batteries observing the direction of the ⊕ and ⊖ polarities.

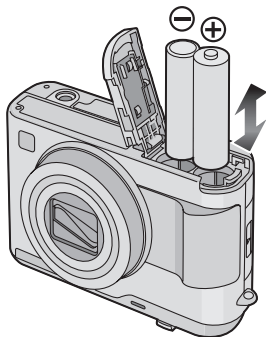

- ### 3
- 1 Close the battery door.
 - 2 Slide the battery door to the end and then close it firmly.

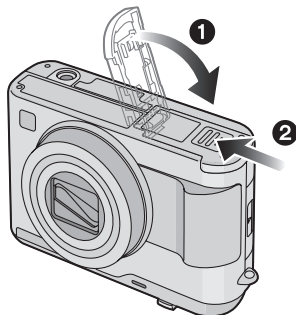

- Select the type of battery in use on [BATTERY TYPE] in the [SETUP] menu. (P24)
- If you will not be using the camera for a long time, remove the batteries.
- When new batteries or fully charged Ni-MH batteries have been inserted for more than 3 hours, the clock setting is stored (in the camera) for at least 3 months even if the batteries are removed. (The storing time may be shorter if the batteries are not charged sufficiently.)
If more than 3 months has passed, the clock setting will be lost. In this case, set the clock again. (P23)
- Do not remove the card and the batteries during an access. The data on the built-in memory or the card may be damaged. (P21)
- Remove the batteries after the LCD monitor and the status indicator (green) are turned off. Otherwise, the settings on the camera may not be stored properly.

Inserting/Removing the Card (Optional)

- Check that the camera is turned off and that the lens is retracted.
- Prepare SD Memory Card (optional) or MultiMediaCard (optional).
- **When you do not use the card, you can record or play back pictures on the built-in memory. (P20)**

1 Slide the card door to open it.

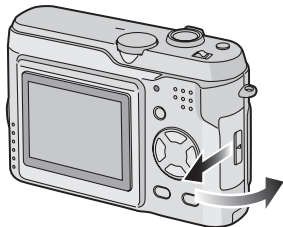

- The card and the data may be damaged if it is inserted or removed while the camera is on.
- We recommend using Panasonic's SD Memory Card. (Use only the genuine SD card with SD Logo.)

2 Insert:

Insert the card fully until it clicks and it is locked with the label facing the back of the camera.

Remove:

Push the card until it clicks, then pull the card out upright.

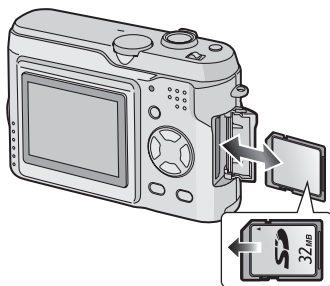

- Check the direction of the card.
- Do not touch the connection terminals on the back side of the card.
- The card may be damaged if it is not fully inserted.

3 ① Close the card door.

- ### ② Slide the card door to the end and then close it firmly.

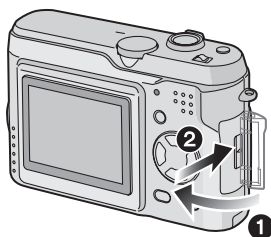

- If the card door cannot be completely closed, remove the card and insert it again.

About the Built-in Memory/the Card

■ Built-in Memory []

When you do not use the card, you can record or play back pictures on the built-in memory.

(The capacity of the built-in memory is about 14 MB.)

■ Card []

When you use the card, you can record or play back pictures on it.

(The built-in memory cannot be used when the card is inserted.)

Icons displayed on the screen:

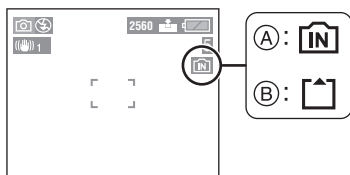

(A): When the built-in memory is used

(B): When the card is used

- **Picture data recorded onto the built-in memory or the card can be copied from the built-in memory to the card and vice versa. (P81)**

■ SD Memory Card (optional) and MultiMediaCard (optional)

The SD Memory Card and MultiMediaCard are small, lightweight, removable external cards. The reading/writing speed of an SD Memory Card is fast. The SD Memory Card is equipped with a Write-Protect switch (A) that can inhibit writing and formatting a card. (When the switch is slid to the [LOCK] side, it is not possible to write or delete data on the card and format it. When the switch is unlocked, these functions become available.)

SD Memory Card

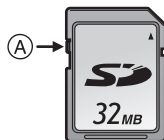

On this unit, you can use SD Memory Cards of the following capacity (from 8 MB to 1 GB).

8 MB, 16 MB, 32 MB, 64 MB, 128 MB, 256 MB, 512 MB, 1 GB (Maximum)

Please confirm the latest information on the following website.

<http://panasonic.co.jp/pavc/global/cs>

(This Site is English only.)

- This unit supports SD Memory Cards formatted in FAT12 system and FAT16 system based on SD Memory Card Specifications.



- The reading/writing speed of a MultiMediaCard is slower than an SD Memory Card. When a MultiMediaCard is used, the performance of certain features may be slightly slower than advertised.
- After recording motion images using the MultiMediaCard, the card access indication may appear for a while, but this is not a malfunction.
- Keep the Memory Card out of reach of children to prevent swallowing.

■ Access to the built-in memory or the card

When pictures are being recorded onto the built-in memory (or the card), the access indication lights red.

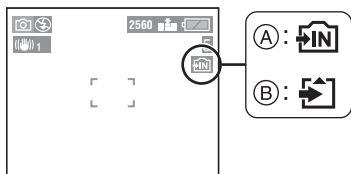

(A): When the built-in memory is used

(B): When the card is used

When the access indication lights, pictures are being read or deleted, or the built-in memory (or the card) is formatted, do not:

- turn the camera off.
- remove the batteries or the card (if used).
- shake or impact the camera.
- disconnect the AC adaptor (DMW-AC1; optional).
(when using the AC adaptor)











The card and the data may be damaged and the camera may not operate normally.







• **The built-in memory (about 14 MB) can be used as a temporary memory instead of the card, when the capacity of the card becomes full.**

- The data on the built-in memory or the card may be damaged or lost due to electromagnetic wave, static electricity or breakdown of the camera or the card. We recommend storing precious data to the PC or other.
- The access time on the built-in memory may become longer than the access time on the card. (Max. about 7 sec.)
- Do not format the built-in memory or the card with a PC. Please use the camera to format the built-in memory and the card. (P82)

Approximate number of recordable pictures and the size

Picture size		2560×1920 (DMC-LZ2)		2304×1728 (DMC-LZ1)		2048×1536 (DMC-LZ2)		1600×1200		1280×960	
Reference for number of pixels		Approx. 5M pixels		Approx. 4M pixels		Approx. 3M pixels		Approx. 2M pixels		Approx. 1.3M pixels	
Quality											
Built-in Memory (Approx. 14 MB)		5	11	8	15	9	17	14	27	22	40
SD Memory Card	16 MB	5	11	8	16	9	17	14	28	22	41
	32 MB	12	24	17	33	19	37	31	59	47	86
	64 MB	25	49	35	69	39	75	63	121	96	176
	128 MB	51	100	71	139	79	153	128	244	195	356
	256 MB	99	195	139	272	154	299	250	476	381	693
	512 MB	197	387	277	539	305	592	495	944	755	1373
	1 GB	395	775	554	1079	610	1185	991	1889	1511	2748

Picture size		640×480		1920×1080 (HDTV)	
Reference for number of pixels		Approx. 0.35M pixels		Approx. 2M pixels	
Quality					
Built-in Memory (Approx. 14 MB)		68	111	13	25
SD Memory Card	16 MB	69	113	13	25
	32 MB	145	236	28	54
	64 MB	298	484	58	110
	128 MB	602	979	118	223
	256 MB	1173	1906	231	435
	512 MB	2324	3777	457	863
	1 GB	4650	7557	916	1727



- If you select a larger picture size, you can print pictures clearly. When you select a smaller picture size, you can record more pictures.
- The numbers are approximations. (If you mix Fine and Standard quality, the number of recordable pictures changes.)
- The number of recordable pictures varies depending on subjects.
- The remaining number of recordable pictures displayed on the screen is an approximation.

Setting Date/Time (Clock Set)

■ Initial setting

The clock is not set when the camera is shipped. When you turn the camera on, the following screen appears.



- When pressing the [MENU] button, the screen shown in step 1 appears.
- The screen disappears in about 5 seconds. Turn the camera on again or select [CLOCK SET] on the [SETUP] menu and then set the clock. (P24)

1 Set date and time.

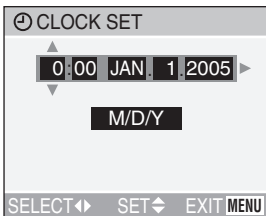

- ◀/▶: Select the desired item.
- ▲/▼: Set date and time.

2 Select [M/D/Y], [D/M/Y] or [Y/M/D].

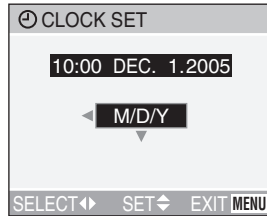

- Close the menu by pressing the [MENU] button 2 times after finishing the setting.
- Check if the clock setting is correct, after turning the camera off and on.



- When new batteries or fully charged Ni-MH batteries have been inserted for more than 3 hours, the clock setting will be stored (in the camera) for at least 3 months even if the batteries are removed. (The storing time may be shorter if the batteries are not charged sufficiently.)
If more than 3 months has passed, the clock setting will be lost. In this case, set the clock again.
- You can set the year from 2000 to 2099. The 24-hour system is used.
- If you do not set the date, the date cannot be printed when you go to a photo studio for digital printing.
- For the date print setting, refer to P74.

About the Setup Menu

- Set the items if necessary. (Refer to P25–27 for each menu item.)

1 Turn the camera on.

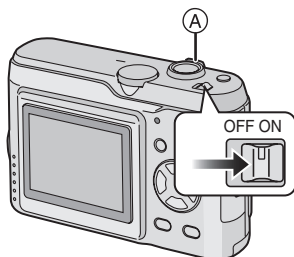

- The menu items depend on the mode selected with the mode dial (P30). In this page, the items in normal picture mode [📷] are indicated.

2 Press the [MENU] button.

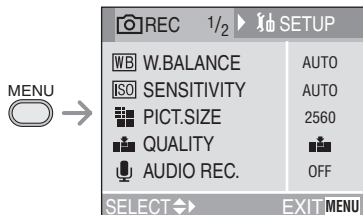

3 Select the [SETUP] Menu.

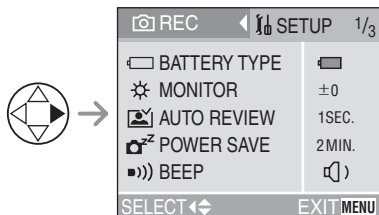

- When rotating the zoom lever (A) toward T or W, the page of the menu screen can be forwarded or reversed.

4 Select the desired item.

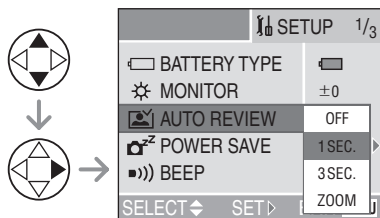

5 Select the desired value.

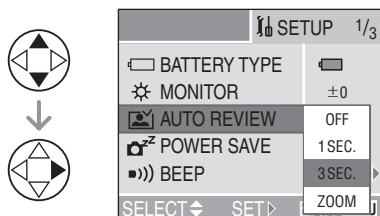

Be sure to press ▶ at the end to store the setting.

- Close the menu by pressing the [MENU] button after finishing the setting. In recording mode, you can also close the menu by pressing the shutter button halfway.

BATTERY TYPE

Select the type of battery in use from the following 2 items.

[] ALKALINE (LR6)/Ni-MH]:

Alkaline batteries or Ni-MH batteries

[] OXYRIDE (ZR6)]:

Oxyride batteries







- If the item on this setting is not selected according to the type of battery in use, the battery indication cannot be displayed correctly.
- The setting on the type of battery also affects simple mode [].

 MONITOR

Adjust the brightness of the LCD monitor in 7 steps.

 AUTO REVIEW

- [OFF]:** The recorded picture does not automatically appear.
- [1SEC.]:** The recorded picture automatically appears on the screen for about 1 second.
- [3SEC.]:** The recorded picture automatically appears on the screen for about 3 seconds.
- [ZOOM]:** The recorded picture automatically appears on the screen for about 1 second. Then it is enlarged 4 times and appears for about 1 second. This mode is useful for confirming focus. Pictures in burst mode, auto bracket, pictures with audio (DMC-LZ2 only) are not enlarged even if [ZOOM] is selected.

- In motion image mode [], auto review function is not activated.
- When pictures are recorded in simple mode [] (P35), any speed [], [] and [] on burst mode (P47) or auto bracket [] (P45), the auto review function is activated regardless of the setting on the auto review function. (The picture is not enlarged.)
- The auto review function is activated while pictures with audio are recorded regardless of the setting on the auto review function. (The picture is not enlarged.) (DMC-LZ2 only)
- The setting for the auto review function is disabled in motion image mode, burst mode, auto bracket or when [AUDIO REC.] is set to [ON] (DMC-LZ2 only).

 POWER SAVE

(Except for the economy mode)

[1MIN.]/[2MIN.]/[5MIN.]/[10MIN.]:

The power save mode is activated (the camera is automatically turned off to save the battery life) if the camera has not been used for the time selected on the setting.

- Press the shutter button halfway or turn the camera off and on to cancel the power save mode.
 - When using the AC adaptor (DMW-AC1; optional)/connecting to a PC or a printer/recording motion images/playing back motion images/during Slide Show, the power save mode is not activated.
 - In simple mode [] (P35), the setting for the power save mode is fixed to [2MIN.].
-

ECO ECONOMY**(Economy mode only)**

The battery life is saved by turning the LCD monitor off automatically while the camera is not in use. (P54) (Press any button to recover from the economy mode.)

[LEVEL 1]: If you do not operate the camera for about 15 seconds, the LCD monitor is turned off.

[LEVEL 2]: If you do not operate the camera for about 15 seconds, or if you do not operate the camera for about 5 seconds after you take a picture, the LCD monitor is turned off.

- The status indicator lights while the LCD monitor is turned off.
- In the economy mode, [POWER SAVE] is fixed to [2MIN.].

■)) BEEP

[]: No operational sound

[]: Soft operational sound

[]: Loud operational sound

- The operational sound setting also affects simple mode [].

 CLOCK SET

Change date and time. (P23)

 NO.RESET

Set this when you want to start the file number of the picture from 0001 on the next recording. (The folder number is updated, and the file number starts from 0001.)

- The folder number can be assigned from 100 to 999.

When the folder number reaches 999, you cannot reset the file number. We recommend formatting the built-in memory or the card after saving the data on a PC or elsewhere.

- To reset the folder number to 100, format the built-in memory or the card first and then use this function to reset the file number.

After that, the reset screen for the folder number appears. Select [Yes] to reset the folder number.

- Refer to P87 for detailed information about the file number and the folder number.
- The file number reset also affects simple mode [].

 RESET

The settings on the [REC] or the [SETUP] menu are reset to the initial settings.

- The setting on [ROTATE DISP.] in the [PLAY] mode menu is also reset. (P72)
- The settings on the type of battery, the folder number and the clock setting are not changed.

 USB MODE

Set the USB communication system.

- Set before connecting to a PC or a printer. (P85)

 VIDEO OUT

(Playback mode only) (P84)

[NTSC]: Video output is set to NTSC system.

[PAL]: Video output is set to PAL system.

[SCN] SCENE MENU

[OFF]: Scene menu does not appear when setting the mode dial to [SCN1] or [SCN2] and the camera is operated in the scene mode currently selected. If you change the scene mode, press the [MENU] button to display the scene menu and then select the desired scene mode.

[AUTO]: Scene menu appears automatically when setting the mode dial to [SCN1] or [SCN2]. Select the desired scene mode.

[i+] LANGUAGE

Set to the language on the menu screen from the following languages.

Set to the desired language with ▲/▼ and store it with ►.

[ENGLISH]: English

[DEUTSCH]: German

[FRANÇAIS]: French

[ESPAÑOL]: Spanish

[ITALIANO]: Italian

[中文]: Chinese (Traditional)

[日本語]: Japanese

- When you set to other language by mistake, select [i+] from the menu icons to set the desired language.
 - The language setting also affects simple mode [♥].
-

About the LCD Monitor

■ Selecting the screen to be used

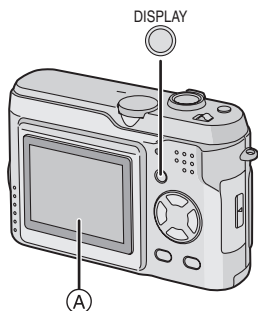

(A) LCD monitor (LCD)

Press the [DISPLAY] button to change the display.

- When the menu screen appears, the [DISPLAY] button is not activated. During 9 pictures multi playback (P50) or playback zoom (P51), the indications on the screen can be turned on and off.

In simple mode [♥] (P35)

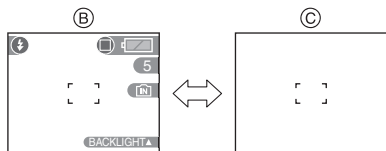

- (B) Normal display
- (C) No display

In recording mode (P31)

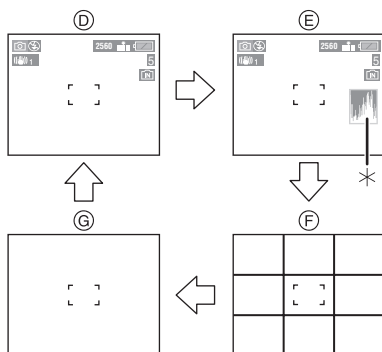

- (D) Normal display
- (E) Display with histogram
- (F) No display (Recording guide line)
- (G) No display
- *Histogram

In playback mode (P49)

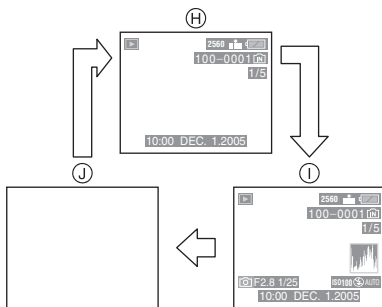

- (H) Normal display
- (I) Display with recorded information and histogram
- (J) No display

■ Recording guide line

When you align the subject on the horizontal and vertical guide lines or the cross point of these lines, you can take pictures with well-designed composition by viewing the size, the slope and the balance of the subject.



■ Histogram

- A histogram is a graph that displays brightness along the horizontal axis (black to white) and the number of pixels at each brightness level on the vertical axis.
 - It allows the camera user to easily check the way a picture is being exposed.
 - It is very useful if manual adjustments of the lens aperture and shutter speed are available, especially in those situations where automatic exposure may be difficult due to uneven lighting. Using the histogram feature will allow you to get the best performance from the camera.
- When the values are concentrated to the left, the picture is under exposed.
 - When the values in the histogram are distributed evenly, the exposure is adequate and the brightness is well-balanced.
 - When the values are concentrated to the right, the picture is over exposed.

Example of histogram

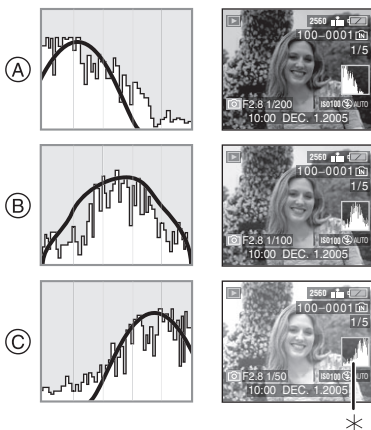

- Under Exposed
 - Properly Exposed
 - Over Exposed
- *Histogram



- **When you take pictures with the flash or in dark places, the histogram is displayed in orange because the recorded picture and the histogram do not match each other.**
- The histogram does not appear when in motion image mode [H], during multi playback and playback zoom.
- The histogram in the recording mode is an approximation.
- The histogram in recording and playback may not match each other.
- The histogram in the camera does not match the one displayed in image editing software used with a PC, etc.

Taking Pictures

■ The Mode Dial

This camera has a mode dial to suit recording of many kinds of scenes.

Select the desired mode and enjoy the variety of recording.

The mode dial can be rotated 360°. Rotate it slowly and securely to adjust to each mode.

(Do not adjust the mode dial to the space between the marks of modes.)

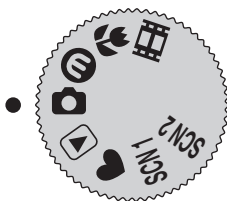

: Normal picture mode (P31)

Use this mode for usual recording.

: Economy mode (P54)

This mode allows you to take pictures reducing the battery power consumption.

: Macro mode (P54)

This mode allows you to take a picture closely focusing on the subject.

: Motion image mode (P55)

This mode allows you to record motion images.

SCN1 : Scene mode 1

SCN2 : Scene mode 2 (P57)

This mode allows you to take pictures depending on the recording scenes.

This mode also allows you to set [SCENE MENU] on the [SETUP] menu to [OFF] and set the scene modes which are frequently used to [SCN1] and [SCN2] on the mode dial.

It is convenient because you can select the scene mode quickly and minimize the operation.

: Simple mode (P35)

This is the recommended mode for beginners.

: Playback mode (P49)

This mode allows you to play back recorded pictures.

■ Normal recording



The camera automatically sets the shutter speed and the aperture value according to the brightness of the subject.

- 1 **Turn the camera on.**
- 2 **Select normal picture mode** [📷].

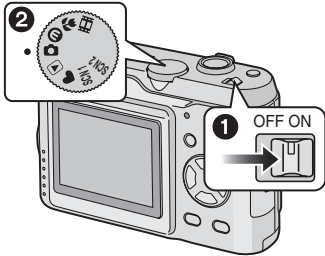

- 2 **Aim the AF area ① to the point you want to focus and then press the shutter button halfway.**

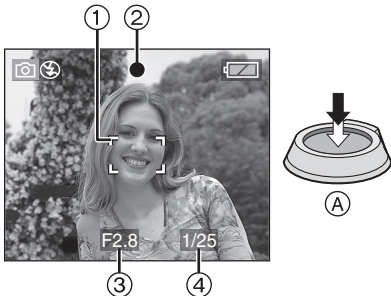

- (A): Press the shutter button halfway to focus.
- The focus indication ② is lit and then the aperture value ③ and the shutter speed ④ are displayed.

3 Take a picture.



- (B): Press the shutter button fully to take the picture.

	When the subject is not focused	When the subject is focused
Focus indication	Blink (green)	On (green)
AF area	Turns from white to red	Turns from white to green
Sound	Beeps 4 times	Beeps 2 times

■ AF/AE Lock (AF: Auto focus/ AE: Auto exposure)



When recording a picture of people with a composition as the above picture, you cannot focus on the subject because it is out of AF area in usual operation.

In this case,

- 1 Aim the AF area at the subject.
 - 2 Press the shutter button halfway to fix the focus and the exposure.
 - When the subject is focused, the focus indication lights.
 - 3 Keeping the focus and the exposure fixed, move the camera as you compose the picture.
 - 4 Press the shutter button fully.
- You can repeatedly retry AF/AE lock before pressing the shutter button fully.



■ Tips for taking good pictures

To take pictures without blurring:

- Hold the camera gently with both hands, keep arms stationary at your side and stand with your feet slightly apart.
- Make sure that camera shake does not occur when you press the shutter button.
- Do not cover the photo flash or microphone (DMC-LZ2 only) with your finger or other objects.
- Do not touch the front of the lens.

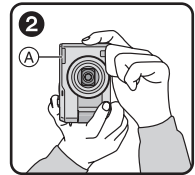
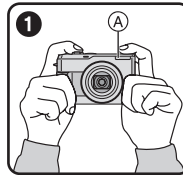

- 1: When holding the camera sideways
 - 2: When holding the camera vertically
- (A): Photo flash
- Especially in the following cases, the shutter speed will be slower. Keep the camera still from the moment you press the shutter button until the picture appears on the screen. We recommend using a tripod.
 - Slow sync./Red-eye reduction [S] (P40)
 - [NIGHT SCENERY], [NIGHT PORTRAIT], [FIREWORKS] and [PARTY] in scene mode (P57)
 - When the shutter speed is slowed in [SLOW SHUTTER] (P68)

■ Focusing

- The focus range is 1.64 feet (50 cm) – ∞ (Wide), 3.94 feet (1.2 m) – ∞ (Tele).
- When you press the shutter button fully with one stroke, pictures may be blurry or unfocused.
- When the focus indication is blinking, the subject is not focused. Press the shutter button halfway and focus on the subject again.
- If the camera will not focus after a few tries, turn it off and on and try again.
- In the following cases, the camera cannot focus on subjects properly.
 - When including both near and distant subjects in a scene.
 - When there is dirt or dust on the glass between the lens and the subject.
 - When there are illuminated or glittering objects around the subject.
 - When taking a picture in a dark place.
 - When the subject is moving fast.
 - When the scene has low contrast.
 - When jitter occurs.
 - When recording a very bright subject.
- We recommend taking pictures using AF/AE lock (P32).
- Even if the focus indication appears and the subject is focused, it is canceled when you release the shutter button. Press the shutter button halfway again.

■ Jitter (camera shake)

- Be careful of jittering when pressing the shutter button, especially when fully zoomed into the subject.
- When jitter could occur because of slow shutter speed, the jitter alert (A) appears.

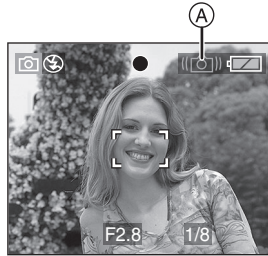

- When the jitter alert appears, we recommend using a tripod. If you cannot use a tripod, be careful of how you hold the camera. (P32)

■ Direction detection function

- If you take pictures by holding the camera vertically, the information of the rotation on the pictures are automatically added and recorded to the pictures.

When [ROTATE DISP.] (P72) is set to [ON], you can rotate and display pictures on the screen or the TV according to the information of the rotation on the pictures.
- When you take pictures by holding the camera vertically, read "Tips for taking good pictures" on P32 carefully.
- This function may not work properly on pictures recorded by aiming the camera up or down.
- In motion image mode [MOVIE], you cannot use the direction detection function.

■ Exposure

- If you press the shutter button halfway when the exposure is not adequate, the indication of the aperture value and the shutter speed turns red. (However, the aperture value and the shutter speed do not turn red when the flash is activated.)
- The brightness of the LCD monitor may differ from that of recorded pictures. The subject looks dark on the LCD monitor, but the actual picture is bright.
- When most of the subjects in the screen are bright (e.g. blue sky on a clear day, snowy field, etc.), the recorded pictures may become dark. In this case, compensate the exposure value on the camera. (P44)



- When you press the shutter button, the LCD monitor may become bright or dark for a moment. This function allows easy adjustment of focus and the recorded picture will not be affected.
- We recommend making sure the clock is set properly before taking pictures. (P23)
- The camera is automatically turned off if you do not operate it within the time set on [POWER SAVE]. (P24)
When operating the camera again, press the shutter button halfway or turn the camera off and on.
- In some cases, if the distance between the camera and the subject is beyond the recordable range when you use the camera, the picture may not be properly focused even if the focus indication is lit.

Taking Pictures in Simple Mode



This mode allows beginners to take pictures easily. Only the most basic functions appear in the menu to make operations simple.

1 Select the desired item and set the desired value.

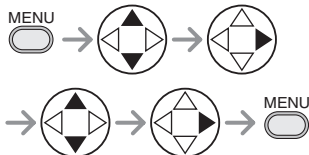
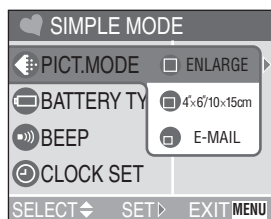

■ Settings in Simple mode

📷 [PICT.MODE]

🖨️ ENLARGE	This selection is intended for situations when large printing (8"×10", Letter etc.) is desired.
📏 4"×6"/ 10×15cm	This selection offers an easy way to produce small "general purpose" prints.
✉️ E-MAIL	This selection favors a smaller file size, optimized for home page and e-mail use.

🔋 [BATTERY TYPE]

Change the type of battery you use. (P24)

🔊 [BEEP]

🔇 OFF	No operational sound
🔊 LOW	Soft operational sound
🔊 HIGH	Loud operational sound

🕒 [CLOCK SET]

Change date and time. (P23)

■ Other Settings in Simple mode

In Simple mode, other settings are fixed as follows. For details, refer to the pages corresponding to each item.

Focus range	1.64 feet (50 cm) – ∞ (Tele) 0.16 feet (5 cm) – ∞ (Wide)	
MONITOR	[0] (standard)	P24
AUTO REVIEW	[1SEC.]	P24
POWER SAVE	[2MIN.]	P24
Self-timer	10 seconds	P43
Optical Image Stabilizer	[MODE1]	P46
Burst speed	Low speed Number of recordable pictures in Burst mode DMC-LZ2: • [ENLARGE]: max. 3 pictures • [4"×6"/10×15cm]: max. 5 pictures • [E-MAIL]: max. 5 pictures DMC-LZ1: • [ENLARGE]: max. 4 pictures • [4"×6"/10×15cm]: max. 7 pictures • [E-MAIL]: max. 7 pictures	P47
White balance	[AUTO]	P63
ISO sensitivity	[AUTO]	P65
Picture size and Quality	• [ENLARGE]: 2560×1920 pixels/Fine (DMC-LZ2) 2304×1728 pixels/Fine (DMC-LZ1) • [4"×6"/10×15cm]: 1600×1200 pixels/Standard • [E-MAIL]: 640×480 pixels/Standard	P65 P66
AF mode	[<input type="checkbox"/>] (1-area-focusing)	P67
Slow shutter	1/8–	P68

■ The Backlight Compensation

Backlight is a situation where light comes from the back of subjects. The subjects such as people become dark when pictures are recorded in backlight. If you press ▲, [B.L.] (compensating backlight ON indication) appears and the backlight compensation function is activated. This function compensates the backlight by brightening the whole of the picture.



- If you press ▲ while [B.L.] is displayed, [B.L.] disappears and the backlight compensation function is canceled.
- When you use the backlight compensation function, we recommend using the flash.



- The settings on [BATTERY TYPE], [BEEP] and [CLOCK SET] in the simple mode are also applied to other recording modes.

- You cannot set the following items in the simple mode.

- [NO.RESET]
- [RESET]
- [USB MODE]
- [VIDEO OUT]
- [LANGUAGE]

However, the setting on [NO.RESET] and [LANGUAGE] in the [SETUP] menu also affects the simple mode.

- You cannot use the following functions in the simple mode.

- White balance fine adjustment
- Exposure compensation
- Auto bracket
- [PICT.SIZE]
- [QUALITY]
- [AUDIO REC.] (DMC-LZ2 only)
- [D.ZOOM]
- [COL.EFFECT]
- [PICT.ADJ.]

However, the setting on [PICT.SIZE] and [QUALITY] corresponds to the setting on [PICT.MODE].

Checking the Recorded Picture (Review)



1 Press ▼.



- The last recorded picture appears for about 10 seconds.
- Press the shutter button halfway or ▼ to cancel the review.
- You can check other pictures by pressing ◀/▶.
- When the recorded pictures are too bright or dim, compensate the exposure. (P44)

2 Enlarge and shift the picture.

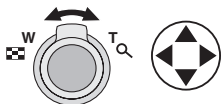

- Q : 1X → 4X → 8X
- : 8X → 4X → 1X

- When you change the magnification or the position to be displayed, the zoom position indication (A) appears for about 1 second to check the enlarged area.

Recorded pictures can be deleted during the review (Quick Deletion)



- Once deleted, pictures cannot be recovered.
- Multi pictures or all pictures can be deleted. Read P52 or P53 to operate them.

Using the Optical Zoom



You can make people and subjects appear closer with the 6 times optical zoom, and landscapes can be recorded in wide angle.



■ To make subjects appear further away use (Wide)

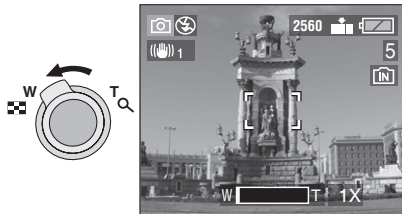

■ To make subjects appear closer use (Tele)

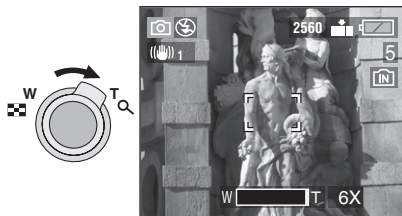

- The optical zoom is set to Wide (1×) when the camera is turned on.
- The picture may have some distortion (typical example: vertical straight line bent outwards). This is due to the lens aberration, which is common to some extent with all photographic lenses. Distortion may be more visible when using a wider area of the zoom lens as you get closer to the subject.
- When using the zoom lens at high magnification, the quality of the picture can be enhanced if a tripod is used. At high magnification, even small movements can cause a slight decrease in picture sharpness.
- If you use the zoom function after focusing on the subject, focus on the subject again.
- When you record motion images, the zoom magnification is fixed to the value set at the start of recording.
- The indicated zoom magnification is an approximation.
- The lens is ejected or retracted according to the zoom position.
- Take care not to interrupt the motion of the lens while the zoom lever is rotated.

Taking Pictures using the Built-in Flash



When you set the flash, you can take pictures using the built-in flash according to the recording condition.

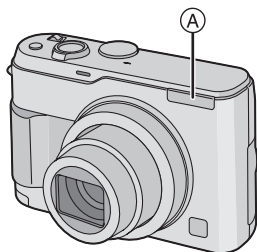

(A): Photo flash

Do not cover it with your finger or any other items.

Switching to the appropriate flash setting



For the selectable flash settings, refer to “Available flash settings by recording mode” on P41.

⚡A: AUTO

The flash is automatically activated according to the recording condition.

⚡A👁: AUTO/Red-eye reduction

The flash is automatically activated according to the recording condition. It reduces the red-eye phenomenon (eyes of the subject appear red in the picture) by triggering the flash before actually recording the picture. After that, the flash is activated for actual recording again.

- The flash is activated 2 times. The first flash is activated only for a preparation of actual recording. The subject should not move until the second flash is finished.
- Use this when you take pictures of people in low lighting conditions.

⚡: Forced ON

The flash is activated every time regardless of the recording condition.

- Use this when your subject is back-lit or under fluorescent light.

⚡👁: Forced ON/Red-eye reduction

- The flash setting is set to Forced ON/Red-eye reduction only when you set to [PARTY] in scene mode. (P57)

⚡S👁: Slow sync./Red-eye reduction

When you take a picture with a dark background landscape, this feature makes the shutter speed slow when the flash is activated, so that the dark background landscape will become bright. Simultaneously it reduces the red-eye phenomenon.

- Use this when you take pictures of people in front of a dark background.

👁: Forced OFF

The flash is not activated in any recording condition.

- Use this when you take pictures in places where the use of the flash is not permitted.

■ Available flash settings by recording mode

The available flash settings depend on the recording mode.

(○: Available, —: Not available)

A	○	○	○	—	○	○	—	—	—	—	○	—
A	○	○	○	—	○	○	—	—	—	—	—	○*
	○	○	○	—	○	○	—	—	—	—	○	○
	—	—	—	—	—	—	—	—	—	○	—	—
S	○	○	○	—	—	—	—	○	—	○	—	—
	○	○	○	○	○	○	○	○	○	○	○	○







*Not available in backlight compensation

■ The available flash range to take pictures

ISO sensitivity	Available flash control range	
	Wide	Tele
AUTO	0.98 feet (30 cm) – 13.8 feet (4.2 m)	1.64 feet (50 cm) – 8.53 feet (2.6 m)
ISO64 (DMC-LZ1 only)	0.98 feet (30 cm) – 5.58 feet (1.7 m)	1.64 feet (50 cm) – 3.28 feet (1 m)
ISO80 (DMC-LZ2 only)	0.98 feet (30 cm) – 6.23 feet (1.9 m)	1.64 feet (50 cm) – 3.61 feet (1.1 m)
ISO100	0.98 feet (30 cm) – 6.89 feet (2.1 m)	1.64 feet (50 cm) – 4.27 feet (1.3 m)
ISO200	1.31 feet (40 cm) – 9.84 feet (3 m)	1.64 feet (50 cm) – 5.91 feet (1.8 m)
ISO400	1.97 feet (60 cm) – 13.8 feet (4.2 m)	1.97 feet (60 cm) – 8.53 feet (2.6 m)

- The available flash range is an approximation.
- Refer to P33 for the focus range.
- Refer to P65 for the ISO sensitivity.
- If the ISO sensitivity is set to [AUTO], it is automatically adjusted from [ISO100] to [ISO400] when you use the flash.
- To avoid noise, we recommend decreasing the ISO sensitivity (P65) or setting [PICT.ADJ.] to [NATURAL]. (P69)

■ Shutter speed for each flash setting

Flash setting	Shutter speed (Sec.)
 : AUTO	1/60 – 1/2000
 : AUTO/Red-eye reduction	1/60 – 1/2000
 : Forced ON	1/60 – 1/2000
 : Forced ON/Red-eye reduction	1/60 – 1/2000
 : Slow sync./Red-eye reduction	1/8* – 1/2000
 : Forced OFF	1/8* – 1/2000
	8 – 1/2000 (In [NIGHT SCENERY] in scene mode)

*The shutter speed changes depending on the slow shutter setting. (P68)



- **Do not stare at the photo flash from close proximity.**
- **If you bring the flash too close to the subjects, they may be distorted or discolored by its heat and lighting.**
- **Do not cover the photo flash with your fingers or any other items.**
- **While the flash is charged, the LCD monitor turns off and you cannot take pictures. The status indicator lights. [Except when the AC adaptor (DMW-AC1; optional) is used.]**
If the remaining battery power is low, the LCD monitor may be turned off for longer time.
- When you take a picture beyond the flash control range, the exposure may not be adjusted properly and the picture may become bright or dark.
- When you repeat taking a picture, recording may be disabled even if the flash is activated. Take a picture after the access indication disappears.
- When the jitter alert appears, we recommend using the flash.
- When you set to burst mode or auto bracket, only 1 picture is recorded for every flash activated.
- The flash icon turns red when activating the flash and pressing the shutter button halfway.
- When taking a picture with the flash, the white balance will be automatically adjusted [except for  (Daylight)], but the white balance may not be properly adjusted if the flash level is insufficient.
- When the shutter speed is fast, the flash effect may not be sufficient.

Taking Pictures with the Self-timer



1 Select the self-timer mode.

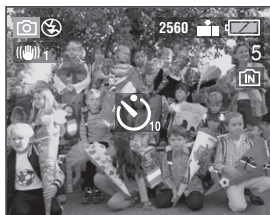

: Self-timer set to 10 seconds



: Self-timer set to 2 seconds



No display: canceled

2 Take the picture.

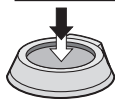
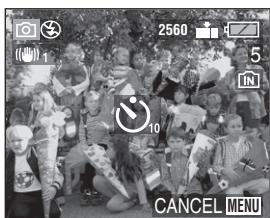

(A)

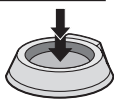

(B)

- (A): Press the shutter button halfway to focus.
- (B): Press the shutter button fully to take the picture.

- The self-timer indicator

(A) blinks and the shutter is activated after 10 seconds (or 2 seconds).

- If you press the [MENU] button when the self-timer is set, the self-timer setting is canceled.

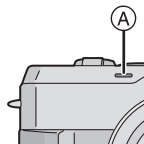

- When using a tripod or in other cases, setting the self-timer to 2 seconds is a convenient way to avoid the jitter caused by pressing the shutter button.
- When you press the shutter button fully with one stroke, the subject is automatically focused just before the recording.
- In simple mode [♥], the self-timer is fixed to 10 seconds. (P35)
- When you set the self-timer in the burst mode, the camera starts taking a picture 2 or 10 seconds after the shutter button is pressed. The number of pictures taken at a time is fixed to 3.
- We recommend using a tripod when recording with the self-timer. (When you use a tripod, make sure the tripod is stable with the camera attached to it.)

Compensating the Exposure



Use this function when you cannot achieve appropriate exposure due to the difference of brightness between the subject and the background.

Under exposed



Compensate the exposure toward positive.



Properly exposed



Over exposed



Compensate the exposure toward negative.

1 Press **▲** several times until **[EXPOSURE]** appears and then compensate the exposure.

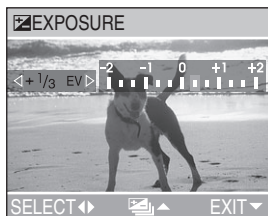

- You can compensate from -2 EV to $+2$ EV in steps of $1/3$ EV.



- EV is an abbreviation of Exposure Value, and it is the amount of light given to the CCD by the aperture value and the shutter speed.
- The compensation range of the exposure will be limited depending on the brightness of the subject.
- The exposure compensation value appears on the lower left of the screen.
- The set exposure value is memorized even if the camera is turned off.

Taking Pictures using Auto Bracket



In this mode, 3 pictures are automatically recorded by each press of the shutter button according to the compensation range of the exposure.

You can select the desired exposure among the 3 types of pictures.

1 Press ▲ several times until [AUTO BRACKET] appears and then set the compensation range of the exposure.

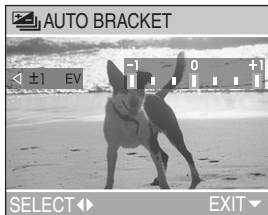

- You can select the exposure from -1 EV to +1 EV in steps of 1/3 EV.
- When you do not use auto bracket, select [OFF].
- When setting the auto bracket, the auto bracket icon appears on the lower left of the screen.



- If the remaining number of recordable pictures is 2 or less, you cannot take pictures by setting auto bracket.
- When taking pictures using auto bracket after the exposure compensation, the pictures are based on the compensated exposure.
 - When the exposure is compensated, the compensated exposure value appears on the lower left of the screen.
- When the flash is activated, you can take only 1 picture.
- When the auto bracket is activated, [AUDIO REC.] cannot be used (DMC-LZ2 only).
- When setting auto bracket and the burst mode simultaneously, auto bracket will be performed.
- The exposure may not be compensated with auto bracket depending on the brightness of the subject.
- Auto bracket is canceled after switching the camera off.
- When setting the auto bracket, the auto review function is activated regardless of the setting on the auto review function. (The picture is not enlarged.) Moreover, the settings for the auto review function on the [SETUP] menu are disabled.
- When the ISO sensitivity is set to [ISO400], the recording interval may become longer due to the process to reduce picture noises. (DMC-LZ2 only)

Optical Image Stabilizer





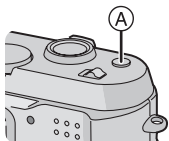

This mode recognizes and compensates jitter. You can reduce blurring caused by jitter especially when you take pictures with the optical zoom set to Tele or when you take pictures indoors where the shutter speed is slowed down.

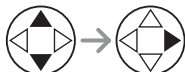
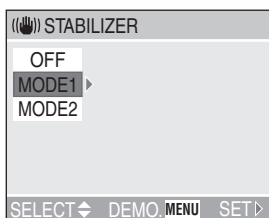

(A): Optical image stabilizer button

1 Press the optical image stabilizer button (A) until [STABILIZER] appears and then select the stabilizer function mode.



MODE1 ()	The stabilizer operates continuously and can assist during photo composition.
MODE2 ()	The stabilizer function is in standby and activates at the moment the shutter captures the image. This mode offers a greater degree of stabilization.
OFF ()	When image stabilization is not needed or when using the camera with a tripod.

■ Demonstration of the optical image stabilizer (Demonstration Mode)



When you press the [MENU] button, the demonstration appears. After the demonstration ends, the screen returns to the stabilizer function mode selection menu. If you want to exit the demonstration halfway through, press the [MENU] button again.

While the demonstration is displayed, the optical zoom is fixed to Wide (1×) and the zoom function cannot be activated. Moreover, you cannot take pictures.



- The stabilizer function may not work sufficiently in the following cases.
 - When too much jitter occurs.
 - In digital zoom range.
 - When taking pictures while following subjects in motion.
 - When the shutter speed is extremely slow due to dark conditions or other reasons.

Be careful of jittering when pressing the shutter button.

- In simple mode [, the stabilizer function mode is fixed to [MODE1] and the stabilizer function menu does not appear.
- In motion image mode [, [MODE2] cannot be set.

Taking Pictures using Burst Mode



1 Select the burst mode.

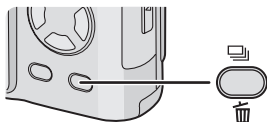
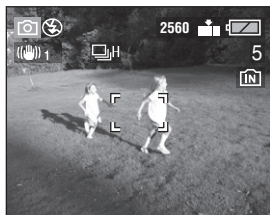

: High speed



: Low speed



: Unlimited*



No display: canceled

*Depending on the memory size, battery power, picture size and quality (compression)

■ Number of pictures recorded in burst mode

	Burst speed (pictures/second)*	Number of recordable pictures (pictures)	
	DMC-LZ2: 3 DMC-LZ1: 4	DMC-LZ2: max. 3	DMC-LZ2: max. 5
	2	DMC-LZ1: max. 4	DMC-LZ1: max. 7
	approx. 1.5	Depends on the remaining capacity of the built-in memory/card.	

*When the shutter speed is higher than 1/60 and the flash is not activated

• When the burst mode setting is set to **Unlimited**

- You can take pictures until the capacity of the built-in memory or the card becomes full.
- The speed of taking pictures becomes slow during a recording.
- In simple mode [], the burst speed is fixed to Low. (P35)



- Hold down the shutter button fully to activate the burst mode.
- When the self-timer is used, the number of recordable pictures in burst mode is fixed to 3.
- When the burst mode is activated, [AUDIO REC.] cannot be used (DMC-LZ2 only).
- If the flash is activated, you can record only 1 picture.
- When setting auto bracket and the burst mode simultaneously, auto bracket will be performed.
- The ways to control the exposure and the white balance vary depending on the burst mode setting. When the burst mode is set to [] or [], they are fixed to the values set for the first picture. (The burst speed is prioritized.) When the burst speed is set to [], they are adjusted each time you take a picture.
- When setting the burst mode, the auto review function is activated regardless of the setting on the auto review function. (The picture is not enlarged.) Moreover, the settings for the auto review function on the [SETUP] menu are disabled.
- Burst mode is not canceled when the camera is switched off.
- Burst mode will not perform as described if a MultiMediaCard is used in place of an SD Memory Card. The reading/writing speed of a MultiMediaCard is slower than that of an SD Memory Card.

Playing Back Pictures



When a card is not inserted, the picture data in the built-in memory appear. When a card is inserted, the picture data in the card appear. (P20)

1 Select the picture.

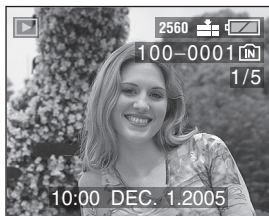

- ◀: Play back the previous picture.
- ▶: Play back the next picture.
- The last recorded picture will be played back first.
- When [ROTATE DISP.] (P72) is set to [ON], pictures recorded by holding the camera vertically are played back vertically.

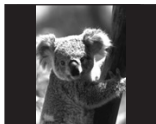

■ Fast forwarding/Fast rewinding

When you keep pressing ◀/▶ during playback, the file number and the page number are updated. If you release ◀/▶ when the number of the desired picture appears, you can play back the picture.

- ▶: Fast forward
- ◀: Fast rewind

- When you keep pressing ◀/▶, the number of files forwarded/rewound at a time is increased.
- If you release ◀/▶ and press them again, the files will be forwarded/rewound one by one.
- In review playback in the recording mode or multi playback, the picture can only be forwarded or rewind one by one.
- When you forward or rewind a large number of pictures, release ◀/▶ once before reaching the picture to be played back, then press ◀/▶ to forward/rewind pictures little by little.



- This camera is based on the DCF standard (Design rule for Camera File system) which was established by the Japan Electronics and Information Technology Industries Association (JEITA).
- When changing the folder name or file name on a PC, the pictures will not be played back.
- The file format that can be played back with the camera is JPEG. (Even JPEG pictures cannot be played back in some cases.)
- When playing back pictures that have been recorded with other equipment, the picture quality may be deteriorated and pictures may not be played back.
- When playing back a non-standard file, the folder/file number is indicated by [—] and the screen may turn black.
- An interference fringe may appear on the screen depending on the subject. This is called moire. This is not a malfunction.

9 Pictures Multi Playback



1 Switch to multi screen.

(The illustration shows the screen when the card is used.)

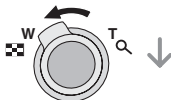
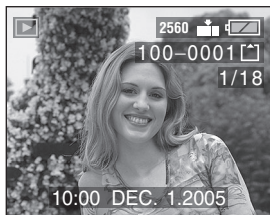

2 Select the pictures.

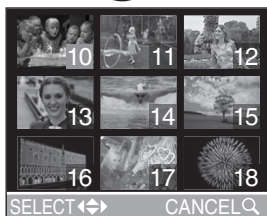
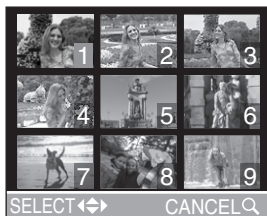

■ To return to the normal playback

Rotate the zoom lever towards [Q] or press the [MENU] button.

- The picture with the number colored in orange appears.

■ To delete a picture during a 9 pictures multi playback

Press the [] button.

When the confirmation screen appears, press ▼ to select [YES], and press ►. (P52)





- Pictures will not be displayed in the rotated direction even if [ROTATE DISP.] is set to [ON] (P72).

Using the Playback Zoom

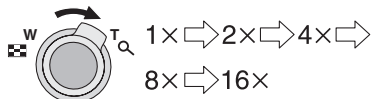

1 Rotate the zoom lever towards [Q] to enlarge the picture.



- When you rotate the zoom lever towards [] after the picture is enlarged, the magnification becomes lower. When you rotate the zoom lever towards [Q], the magnification becomes higher.
- When you change the magnification, the zoom position indication  appears for about 1 second to check the position of the section enlarged.
- When you press the [MENU] button, the magnification reverts to 1x.



2 Shift the picture.



- When you move the position to be displayed, the zoom position indication is displayed for about 1 second.

■ To delete a picture during playback zoom

Press the [] button.

When the confirmation screen appears, press  to select [YES], and press . (P52)



- When you use the zoom function on rotated pictures, they are not displayed in the rotated direction (P72).
 - The more the picture is enlarged, the more its quality deteriorates.
 - The playback zoom may not operate if pictures have been recorded with other equipment.
 - Even if the indications on the LCD monitor are turned off in normal playback mode (P28), the magnification and enabled operations appear on the LCD monitor when the playback zoom is activated.
 - You can switch whether you turn the indications on the LCD monitor on or off by pressing the [DISPLAY] button.
- When you set the magnification to 1x, the indications on the LCD monitor are displayed as in normal playback mode.

Deleting Pictures



When a card is not inserted, the picture data in the built-in memory will be deleted. When a card is inserted, the picture data in the card will be deleted. (P20)

■ To delete a single picture

1 Select the picture to be deleted.

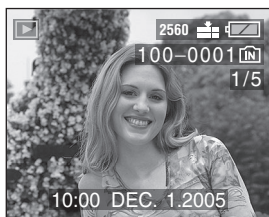

- ◀: Play back the previous picture.
- ▶: Play back the next picture.

2 Delete the picture.



- While deleting the picture, [🗑️] appears on the screen.

■ To delete multiple pictures

1 Select [MULTI DELETE].

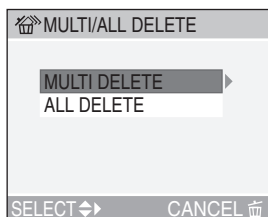

2 times

2 Select the pictures to be deleted.



- Repeat the above procedure.
- The selected pictures appear with [🗑️]. When ▼ is pressed again, the setting is canceled.
- The icon [🔒] blinks red if the selected picture cannot be deleted. Cancel the protect setting. (P75)

3 Delete the pictures.

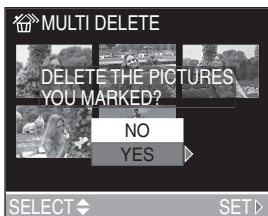

- It is possible to delete up to 50 pictures all at once.

■ To delete all pictures

1 Select [ALL DELETE].

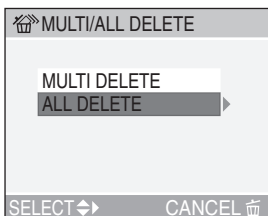

2 times

2 Delete all of the pictures.

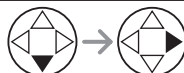

- When you delete all pictures, only pictures in either of the built-in memory or the card can be deleted. (You cannot delete pictures in both the built-in memory and the card at the same time.)



- Once deleted, pictures cannot be recovered. Please double-check before deleting pictures.
- Do not turn off the camera while deleting.
- When you delete pictures, use batteries with sufficient battery power (P14) or use the AC adaptor (DMW-AC1; optional).
- Pictures that are protected [P75] or do not conform to DCF standard (P49) will not be deleted even if [ALL DELETE] is selected.

Using the Mode Dial

Economy mode



In economy mode, the camera reduces the brightness of the LCD monitor and works as follows to reduce the battery power consumption. On other operations in this mode, the camera works the same as the normal picture mode .

Refer to P24 for settings.

Conditions:

- When 15 seconds passed without any operation.
- When 5 seconds passed without any operation after taking a picture. (Effective only when [ECONOMY] on the [SETUP] menu is set to [LEVEL 2].) (P26)

Operation:

- The message [MONITOR OFF] blinks, the LCD monitor turns off and then the status indicator lights.

How to turn the LCD monitor on again:

Press any key.

Power save:

If 2 minutes passed without any operation in economy mode, the camera is turned off and the power save mode is activated. To cancel the power save mode, press the shutter button halfway or turn the camera off and then turn it on again.



- The economy mode is not activated in the following cases (The power save mode is activated.):
 - While the menu screen is displayed
 - While the self-timer is set
- When you use the AC adaptor (DMW-AC1; optional), the power save mode is not activated.

Macro mode



This mode allows you to take close-up pictures of the subject, e.g. When taking pictures of flowers.

You can take pictures approaching the subject at a distance up to 0.16 feet (5 cm) from the lens by rotating the zoom lever upmost to Wide (1×).

Focus range

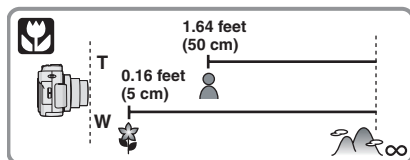

- We recommend using a tripod.
- When the subject is close to the camera, the effective focus range (depth of field) is much narrowed. Therefore, you will have difficulty in focusing on the subject if the distance between the camera and the subject is changed after the subject is focused.
- When the camera lens is at a distance beyond the available range from the subject, the subject may not be focused even if the focus indication lights.
- The available flash range is about 0.98 feet (30 cm) – 13.8 feet (4.2 m) (Wide). (This is applied when you set the ISO sensitivity to [AUTO].)
- When you take pictures at close range in macro mode, the resolution of the peripheral of the picture may be slightly decreased. However, this is not a malfunction.

Motion image mode



This mode allows you to record motion images.

1 Select [MOTION RATE].

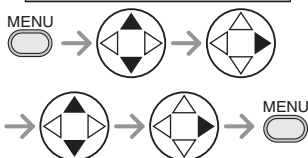
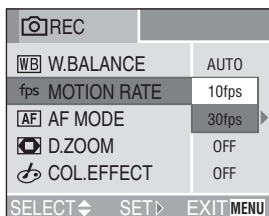

• [10fps]:

Recording motion images for a longer time is available though the quality will be less than the quality recorded at [30fps]. The file size is smaller, so the files are suitable to be attached to e-mails.

• [30fps]:

The motion of the recorded image is smooth, but the file size is large.

- fps (frame per second); This refers to the number of frames used in 1 second.
- Close the menu by pressing the shutter button halfway or the [MENU] button after finishing the setting.

2 Press the shutter button halfway.

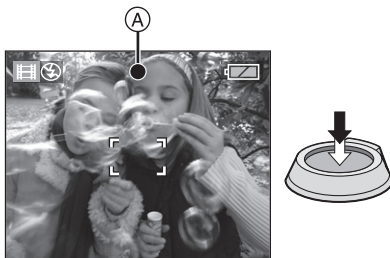

- When the subject is focused, the focus indication (A) lights.

3 Press the shutter button fully to start the recording.



- The remaining recording time (approximation) appears on the screen.
- The audio recording starts simultaneously from the built-in microphone of the camera. (DMC-LZ2 only)
- By pressing the shutter button fully again, the recording stops.
- If the built-in memory or the card becomes full during recording, the camera stops recording automatically.

■ Available recording time (seconds)

		Motion rate	
		10fps	30fps
Built-in Memory (Approx. 14 MB)		81	26
SD Memory Card	16 MB	75	25
	32 MB	160	55
	64 MB	350	120
	128 MB	720	240
	256 MB	1440	480
	512 MB	2870	980
	1 GB	5700	1950

- The recordable time is an approximation.



- The picture size is fixed to 320×240 pixels.
- The motion images cannot be recorded without audio on DMC-LZ2.
- **You cannot record audio on DMC-LZ1.**
- If using a MultiMediaCard, after recording motion images, the card access indication may appear for a while, but this is not a malfunction. The file is being loaded to the MultiMediaCard.
- The settings of auto focus/zoom/aperture values are fixed to what they are when recording starts (in the first frame).
- Depending on the type of the card, recording may stop while you are recording motion images.
- When motion images recorded with the camera are played back on other equipment, the quality of pictures and sounds may be deteriorated or it may not be possible to play them back.
- Motion images recorded with setting [MOTION RATE] to [30fps] on the camera cannot be played back on a camera which does not support [30fps] of motion rate.
- In motion image mode [], you cannot use the direction detection function and the review function.
- You cannot set [MODE2] on the optical image stabilizer function.

SCN1 SCN2 **Scene mode**

Set the mode dial to the scene mode to display the scene menu.

When [SCENE MENU] on the [SETUP] menu (P24) is set to [OFF], press the [MENU] button to display the scene menu.

Menu items

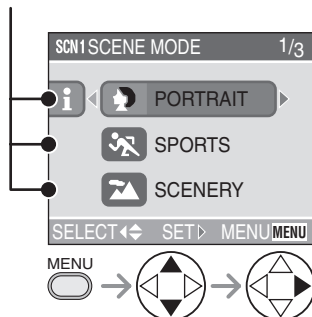

- When you press ◀, the explanations for each scene mode are displayed. (When you press ▶, the screen returns to the scene menu.)
- When rotating the zoom lever toward T or W, the page of the menu screen can be forwarded or reversed.
- If you press the [MENU] button while the scene menu is displayed, you can set the [REC] mode menu (P62) and the [SETUP] menu (P24).

: [PORTRAIT] (P58)

: [SPORTS] (P58)

: [SCENERY] (P59)

: [NIGHT SCENERY] (P59)

: [NIGHT PORTRAIT] (P60)

: [FIREWORKS] (P60)

: [PARTY] (P61)

: [SNOW] (P61)



- When you take pictures with a scene mode which is not adequate for the purpose, the hue may differ from the actual scene.
- When you want to change the brightness of the picture to be recorded, compensate the exposure. (P44)
- The following functions cannot be set in scene mode.
 - White balance (P63)
 - ISO sensitivity (P65)
 - Color effect (P69)
 - Picture adjustment (P69)

Portrait mode

Select this mode when you want to take pictures of people.

This mode allows you to make the subject stand out and adjust the exposure and the hue to achieve a healthy complexion on the subject.



■ Technique for Portrait mode

To make this mode more effective:

- 1 Rotate the zoom lever to Tele as far as possible.
- 2 Be close to the subject.
- 3 Select a background which is far from the camera.



- This mode is suitable for outdoors in the daytime.
- The ISO sensitivity is fixed to [AUTO].

Sports mode

This mode allows you to take pictures of a fast moving subject. (e.g. When taking pictures of outdoor sports.)

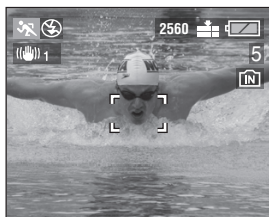

■ Technique for Sports mode

To take a sharp picture of a fast moving subject, the shutter speed becomes faster than usual. This mode is more effective when taking pictures in the daytime on a clear day.



- This mode is suitable for outdoors in the daytime, keeping 16.4 feet (5 m) or more away from the subject.
- The ISO sensitivity is fixed to [AUTO].

Scenery mode

This mode allows you to take a picture of a wide landscape. The camera focuses on a distant subject preferentially.

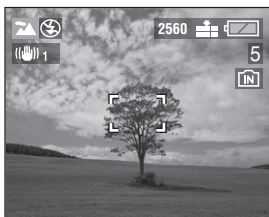

- The focus range is 16.4 feet (5 m) – ∞.
- The ISO sensitivity is fixed to [AUTO].
- The flash setting is fixed to Forced OFF [].

Night scenery mode

This mode allows you to take a picture of a nightscape. The landscape can be recorded vividly by slowing down the shutter speed.

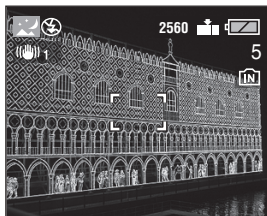

■ Technique for Night scenery mode

- Since the shutter speed becomes slow (max. about 8 sec.), use a tripod.



- The focus range is 16.4 feet (5 m) – ∞.
- The shutter may be kept closed (max. about 8 sec.) after taking a picture because of signal conditioning, but it is not a malfunction.
- When you take pictures in dark places, noise may become visible.
- The ISO sensitivity is fixed to [ISO80] (DMC-LZ2)/[ISO64] (DMC-LZ1).
- The flash setting is fixed to Forced OFF [].

Night portrait mode

This mode allows you to take pictures against a night landscape. The subject can be recorded with brightness in real life by using the flash and slowing down the shutter speed.

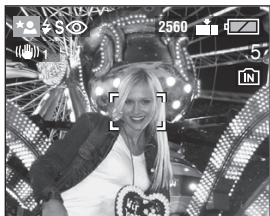



■ Technique for Night portrait mode

• Use the flash.

- Since the shutter speed becomes slow, we recommend using a tripod.
- Keep the subject still for about 1 second when taking a picture.
- We recommend taking pictures by rotating the zoom lever to Wide (1×) and being at a distance about 4.92 feet (1.5 m) from the subject.



- The focus range is 3.94 feet (1.2 m) – 16.4 feet (5 m). (Refer to P41 for the flash control range.)
- The shutter may be kept closed (max. about 1 sec.) after taking a picture because of signal conditioning, but it is not a malfunction.
- When you take pictures in dark places, noise may become visible.
- When the flash setting is set to Forced OFF [, press **▶** to set to Slow sync./Red-eye reduction []. (The flash setting is fixed to Slow sync./Red-eye reduction [] and the flash is always activated.)
- The ISO sensitivity is fixed to [AUTO].

Fireworks mode

This mode allows you to take beautiful pictures of fireworks exploding in the night sky. The shutter speed is automatically adjusted for taking pictures of fireworks.

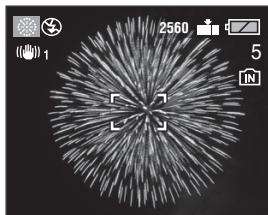

■ Technique for Fireworks mode

- We recommend using a tripod.



- The ISO sensitivity is fixed to [AUTO].
- This mode is most suitable when the camera is at a distance of 32.8 feet (10 m) or more from the subject.
- The flash setting is fixed to Forced OFF [].

Party mode

This mode allows you to take a picture according to the atmosphere of the situation (e.g. a wedding reception, a party in a room, etc.).



Both the people and the background can be recorded with brightness in real life by using the flash and slowing down the shutter speed.



■ Technique for Party mode

- Since the shutter speed becomes slow, we recommend using a tripod.
- We recommend taking pictures by rotating the zoom lever to Wide (1×) and being at a distance about 4.92 feet (1.5 m) from the subject.



- When the flash is activated, the flash setting can be set to Forced ON/Red-eye reduction [] or Slow sync./Red-eye reduction [].
- The ISO sensitivity is fixed to [AUTO].

Snow mode

This mode allows you to take a picture in locations such as skiing resorts and locations near snowy mountains. The exposure and the white balance are adjusted to make the white color of the snow stand out.



- The ISO sensitivity is fixed to [AUTO].

Using the [REC] mode menu



Setting the hue, picture quality adjustment, etc. allows you to create wide variations on taking pictures.

- Set the mode dial to the desired recording mode.

Menu items

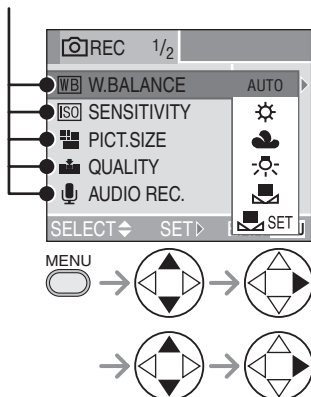

[WB] : [W.BALANCE] (P63)

[ISO] : [SENSITIVITY] (P65)

[PICT.SIZE] (P65)

[QUALITY] (P66)

[AUDIO REC.] (DMC-LZ2 only)
(P66)

[AF MODE] (P67)

[SLOW SHUTTER] (P68)

[D.ZOOM] (P68)

[COL.EFFECT] (P69)

[PICT.ADJ.] (P69)

- When rotating the zoom lever toward T or W, the page of the menu screen can be forwarded or reversed.
- Close the menu by pressing the shutter button halfway or the [MENU] button after finishing the setting.

WB White Balance [W.BALANCE]

This function allows you to reproduce a white color closer to the tone in real life on the pictures recorded under sunlight, halogen lighting, etc. in which the white color may appear reddish or bluish.

AUTO	for auto setting (auto white balance)
(Daylight)	for recording outdoors on a bright day
(Cloudy)	for recording under a cloudy sky or shaded area
(Halogen)	for recording under halogen lighting
(White set)	for using the preset white balance
(White set)	for setting the white balance again

- When setting the white balance to the mode except [AUTO], you can finely adjust the white balance.

Auto White Balance

Use of auto white balance adjustment in inappropriate lighting conditions may result in reddish or bluish pictures. Where the subject is surrounded by many light sources, auto white balance adjustment may not operate properly.

In this case, set the white balance to a mode except [AUTO] manually.

- 1 The range that is controlled by the auto white balance adjustment mode of the camera
- 2 Blue sky
- 3 Cloudy sky (Rain)
- 4 TV screen
- 5 Sunlight
- 6 White fluorescent light
- 7 Incandescent light bulb
- 8 Sunrise and sunset
- 9 Candlelight

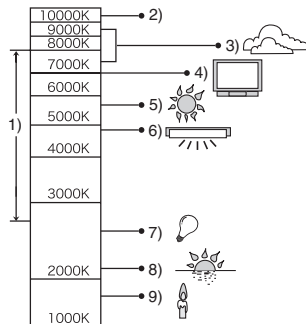

K=Kelvin Color Temperature

■ Setting the White Balance manually (White set)





Use this mode when you want to set the white balance manually.

- 1 Set to [SET] (White Set) and then press **▶**.
- 2 Aim the camera at a sheet of white paper or a similar white object so that the frame in the center is filled by the white object only and then press **▶**.



■ Finely Adjusting the White Balance (White Balance Fine Adjustment)

When you cannot acquire the desired hue by setting the white balance, you can adjust the white balance finely.



- 1 Set the white balance to []/[]/[]/[]. (P63)
- 2 Press **▲** several times until [WB ADJUST.] appears.



- 3 Finely adjust the white balance.
 - **▶ [BLUE]**: Press when the hue is reddish.
 - **◀ [RED]**: Press when the hue is bluish.



About the white balance

- In simple mode [], the white balance is fixed to [AUTO].
- When taking a picture with the flash, the white balance will be automatically adjusted [except for [] (Daylight)], but the white balance may not be properly adjusted if the flash level is insufficient.

About the white balance fine adjustment

- The white balance icon on the screen turns red or blue.
- You can set the value independently for each of the modes in white balance.
- The setting on the fine adjustment of the white balance is reflected to the picture when taking a picture with the flash.
- When you set the white balance using the White set [SET], the adjustment level is set to "0".
- When the color effect is set to any of [COOL], [WARM], [B/W] or [SEPIA] (P69), you cannot finely adjust the white balance.

 **ISO Sensitivity [SENSITIVITY]**

ISO sensitivity represents the sensitivity to light in values. If you set the ISO sensitivity higher, the camera becomes more suitable for recording in dark places.

- When setting to [AUTO], the ISO sensitivity is automatically adjusted in the range described below according to the brightness.

DMC-LZ2: [ISO80]–[ISO200]

DMC-LZ1: [ISO64]–[ISO200]

(It can be adjusted from [ISO100] to [ISO400] when using the flash.)

(Common to DMC-LZ2/DMC-LZ1)

ISO sensitivity	80 ← → 400 (DMC-LZ2)
	64 ← → 400 (DMC-LZ1)
Use in bright places (e.g. outdoors)	Suitable Not suitable
Use in dark places	Not suitable Suitable
Shutter speed	Slow Fast
Noise	Less Increased



- In simple mode [♥], motion image mode [H] or scene mode (P57), ISO sensitivity is fixed to [AUTO]. (In [NIGHT SCENERY] in scene mode, it is fixed to [ISO80] (DMC-LZ2)/[ISO64] (DMC-LZ1).)
- To avoid picture noise, we recommend decreasing the ISO sensitivity or setting [PICT.ADJ.] to [NATURAL]. (P69)

 **Picture Size [PICT.SIZE]**

When you select a larger picture size, you can print pictures clearly.

When you select a smaller picture size (640×480 pixels), you can record more pictures. In addition, it is convenient to attach the picture to an e-mail or post it on a website because the file size is small.

2560 (DMC-LZ2)	2560×1920 pixels
2304 (DMC-LZ1)	2304×1728 pixels
2048 (DMC-LZ2)	2048×1536 pixels
1600	1600×1200 pixels
1280	1280×960 pixels
640	640×480 pixels
HDTV	1920×1080 pixels



- For details on how to playback pictures recorded using [HDTV] mode on a High-Definition TV (HDTV has a 16:9 aspect), refer to P84.
- Both ends of the pictures recorded using [HDTV] mode may be cut off in printing. Check the picture before printing. (P101)



- In motion image mode [H], the picture size is fixed to 320×240 pixels.
- Pictures may appear like a mosaic depending on the subject or the recording condition.
- The number of recordable pictures depends on the subject.
- The number of remaining pictures displayed on the screen may not correspond with recorded frames.
- Refer to P22 for the number of recordable pictures.

 **Quality [QUALITY]**

You can select 2 types of quality (compression rate) according to the usage of the picture.

	Fine (Low compression): This type gives priority to picture quality. Picture quality will be high.
	Standard (High compression): This type gives priority to the number of recordable pictures and records standard quality pictures.





- Pictures may appear like a mosaic depending on the subject or the recording condition.
- The number of recordable pictures depends on the subject.
- The number of remaining pictures displayed on the screen may not correspond with recorded frames.
- Refer to P22 for the number of recordable pictures.

 **Audio Recording [AUDIO REC.]**
(DMC-LZ2 only)

You can take a picture with audio.

- When you set [AUDIO REC.] to [ON],  appears on the screen.
- When you start recording by focusing on the subject and pressing the shutter button, the audio recording will be automatically stopped in about 5 seconds. There is no need to keep pressing the shutter button.
- Audio is recorded from the built-in microphone of the camera.
- If you press the [MENU] button during the audio recording, the audio recording will be canceled. The audio cannot be recorded.
- You cannot record pictures with audio in auto bracket or burst mode.
- When audio is recorded with each picture, the total number of pictures that can be stored on each card will slightly decrease.

AF AF Mode [AF MODE]

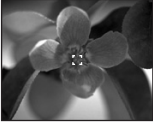
	<p>5-area-focusing: The camera focuses on any of 5 focus areas. You can record a picture in free composition without limiting the position of the subject.</p> 
	<p>3-area-focusing: The camera focuses on any of the left, center and right of the screen. This mode allows you to focus on the subject faster than any other modes in AF mode.</p> 
	<p>1-area-focusing: The camera focuses on the subject in AF area on the center of the screen.</p> 
	<p>Spot-focusing: The camera focuses on the limited and narrow area in the screen.</p> 



- When setting to 3-area-focusing, pictures may become still while being focused on, however, this is not a malfunction.
- When using the digital zoom or when you take pictures in dark places, the AF area is displayed on the center of the screen with a size wider than usual.



- When multiple AF areas (max. 5 areas) light at the same time, the camera is focusing on all the AF areas. The focus position is not predetermined because it is set to the position that the camera automatically determines at the time of focusing. If you want to determine the focus position to take pictures, switch the AF mode to 1-area-focusing mode.

SLOW Slow Shutter [SLOW SHUTTER]

The shutter speed can be automatically adjusted. However, if you want brighter pictures, you can manually select a slower shutter speed. This is especially effective if you want to take pictures where both the night landscape and the subject are bright, using [NIGHT PORTRAIT] in scene mode (P57).

The slow shutter speed values you can select are: [1/8-], [1/4-], [1/2-] and [1-].

Slow shutter setting	1/8- ←————→ 1-	
Brightness	Darker	Brighter
Jitter	Less	More

■ Example

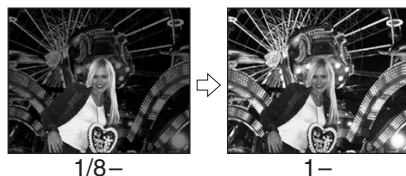

- Usually, set to [1/8-] to take pictures. (When you select slow shutter speed values other than [1/8-], [SLOW] appears on the lower left of the LCD monitor.)
- When you set shutter speed slower on [SLOW SHUTTER], we recommend using a tripod because jitters become easier to occur.
- You cannot set the slow shutter in [NIGHT SCENERY] and [FIREWORKS] in scene mode. (P57)

Digital Zoom [D.ZOOM]

It is possible to further magnify a subject already magnified 6 times with the optical zoom 4 more times with the digital zoom, thereby reaching a maximum of 24 times.

■ Entering the digital zoom range

When you rotate the zoom lever to the extreme Tele position, the on-screen zoom indication may momentarily pause. This is not a malfunction.

You can enter the digital zoom range by continuously rotating the zoom lever to Tele or releasing the zoom lever once and then rotate it to Tele again.

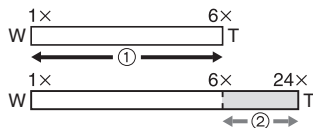

- ① Optical zoom
- ② Digital zoom



- When using the digital zoom, the picture quality becomes deteriorated.
- In the digital zoom range, the stabilizer function may not be effective.
- We recommend using a tripod.
- The indicated zoom magnification is an approximation.
- The AF area is displayed with a size wider than usual and set only to a point on the center of the screen in the digital zoom range. (P67)

 **Color Effect [COL.EFFECT]**

You can use 4 types of color effects depending on the atmosphere of the picture.

COOL	The picture becomes bluish.
WARM	The picture becomes reddish.
B/W	The picture becomes black and white.
SEPIA	The picture becomes sepia.

 **Picture Adjustment [PICT.ADJ.]**

Use this function according to the recording situation and the atmosphere of the picture.

NATURAL	The picture becomes softer.
VIVID	The picture becomes sharper.



-
- When you take pictures in dark places, noise may become visible. To avoid noise, we recommend setting [PICT.ADJ.] to [NATURAL].

Playing Back Pictures with Audio/Motion Images



■ Pictures with audio (DMC-LZ2 only)

Select the picture with audio icon [] and play back the audio.

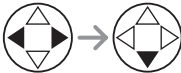

■ Motion images

Select the picture with the motion image icon [] and play back the motion images.

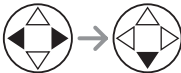

- The cursor displayed during playback corresponds to ▲/▼/◀/▶.
- Motion image playback stops and the normal playback is restored by pressing ▼.



■ Fast forwarding/Fast rewinding

During motion image playback, keep pressing ◀/▶.

▶: Fast forward

◀: Fast rewind

- When releasing the button, it turns to normal motion image playback.

■ To pause

Press ▲ during motion image playback.

- Press ▲ again to cancel pause.



- You can record audio on DMC-LZ2. However, you cannot play audio only with the camera. When you want to play audio, connect the camera to TV (P84) or PC (P86).
- You cannot record audio on DMC-LZ1.

- The picture with audio cannot be resized (P78) or trimmed (P79).
- You cannot use the zoom function while playing back or pausing motion images.
- The file format that can be played back with the camera is QuickTime Motion JPEG.
- Some QuickTime Motion JPEG files recorded by a PC or other equipment may not be played back with the camera.
- When playing back motion images that have been recorded with other equipment, the quality of images may be deteriorated or it may not be possible to play them back.
- When using a high capacity card, it is possible that fast rewinding may be slower than usual.

Using the [PLAY] mode menu



You can use various functions in playback mode such as a rotating function or protections for recorded pictures.

Menu items

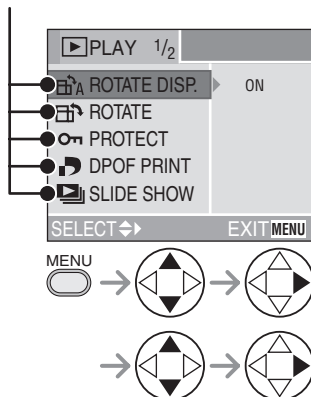

: [ROTATE DISP.] (P72)

: [ROTATE] (P72)

: [PROTECT] (P75)

: [DPOF PRINT] (P73)

: [SLIDE SHOW] (P76)

: [AUDIO DUB.] (DMC-LZ2 only)
(P77)

: [RESIZE] (P78)

: [TRIMMING] (P79)

: [COPY] (P81)

: [FORMAT] (P82)

- When rotating the zoom lever toward T or W, the page of the menu screen can be forwarded or reversed.
- After selecting a menu item with the operation described above, make settings for each menu.



Displaying pictures in a direction at the time of recording [ROTATE DISP.]

This mode allows you to display pictures recorded by holding the camera vertically or pictures rotated in [ROTATE] function in the rotated direction.

1 Select [ON] to set it.

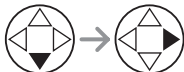
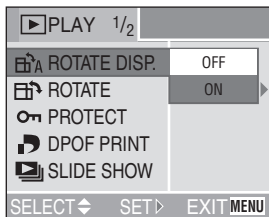

- When you select [OFF], the pictures are displayed without being rotated.
- Refer to P49 for how to play back pictures.



- When you take pictures by holding the camera vertically, read "Tips for taking good pictures" on P32 carefully.
- The direction detection function (P33) may not work properly on pictures recorded by aiming the camera up or down.
- Only still pictures in normal playback can be rotated. When playing back rotated pictures in zoom playback or multi playback, pictures appear in original orientation.
- You can rotate and display pictures by using [ROTATE] function even if you do not take pictures by holding the camera vertically.



Rotating the Picture [ROTATE]

You can rotate the recorded pictures in steps of 90° and display them.

■ Example

When rotating clockwise (↻)

Original picture

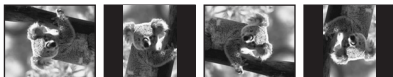

1 Select the picture to be rotated and set it.

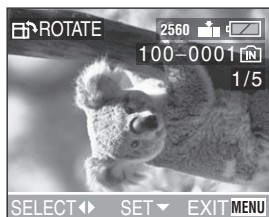

- Pictures recorded in motion image mode [] and protected pictures cannot be rotated.

2 Select the direction to rotate the picture.

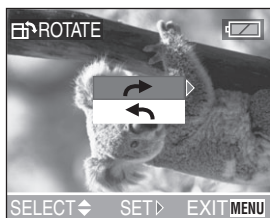

	The picture rotates clockwise in steps of 90°.
	The picture rotates counter-clockwise in steps of 90°.



- When you play back pictures on a PC, you cannot play back pictures keeping the rotated direction without an OS or software compatible with Exif.
- Exif is the file format for still pictures, to which recording information and other can be added, established by JEITA [Japan Electronics and Information Technology Industries Association].
- When [ROTATE DISP.] is set to [OFF], [ROTATE] function is disabled.
- When pictures are recorded by holding the camera vertically, the pictures are played back vertically (the pictures are rotated).

Setting the Picture to be Printed and the Number of Prints [DPOF PRINT]

DPOF (Digital Print Order Format) is a system that allows the user to select which pictures are to be printed, how many copies of each picture will be printed or whether the recording date is to be printed on compatible photo printers or commercial photo printing services.

For details, ask photo printing service.

When you want to use commercial photo printing service to print pictures recorded in the built-in memory, copy them onto the card (P81) and then set the DPOF setting.

For more information please visit:

http://panasonic.jp/dc/dpof_110/white_e.htm

1 Select [SINGLE], [MULTI] or [CANCEL].

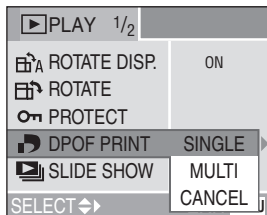

■ Single setting

Select the picture and set the number of prints.

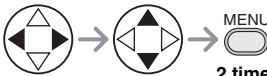

- The number of prints can be set from 0 to 999.
- The number of prints icon [] appears.
- When the number of prints is set to "0", DPOF print setting is canceled.

■ Multi setting

Select the pictures and set the number of prints.

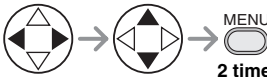

- Repeat the above procedure.
- The number of prints can be set from 0 to 999.
- The number of prints icon [] appears.
- When the number of prints is set to "0", DPOF print setting is canceled.

■ To cancel all settings

Select [YES] to cancel all settings.

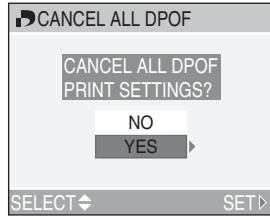

- When a card is not inserted, DPOF print settings on the built-in memory are canceled. When a card is inserted, DPOF print settings on the card are canceled.

■ To print the date

You can set/cancel the printing with the recorded date by pressing the [DISPLAY] button after setting the number of prints.



- The date print icon [] appears.
- When using the software "SD Viewer for DSC" in the CD-ROM (supplied), you can print pictures with the date by setting the position on the print preview screen. For details, refer to the separate operating instructions about PC connection.
- When you go to a photo studio for digital printing, be sure to order the printing of the date additionally if required.

- The date may not be printed depending on photo studios or printers even if you set the date print. For further information, ask the photo studio or refer to the operating instructions of the printer.



- DPOF print setting is a convenient function when you print pictures with printers supporting PictBridge. (P88)
- DPOF is an abbreviation of Digital Print Order Format. This feature allows you to write print information into the media and to use such information on the DPOF-compliant system.
- If the file is not based on the DCF standard, the DPOF print setting cannot be set. DCF is an abbreviation of [Design rule for Camera File system], stipulated by JEITA [Japan Electronics and Information Technology Industries Association].
- When setting the DPOF print on the camera, delete any previous DPOF print settings made by other equipment.

Preventing Accidental Erasure of the Picture [PROTECT]

You can set the protection for the pictures which you do not want to be deleted by accident.

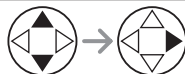
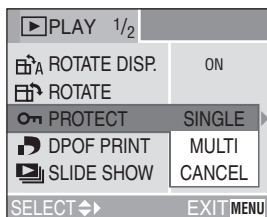

1 Select [SINGLE], [MULTI] or [CANCEL].

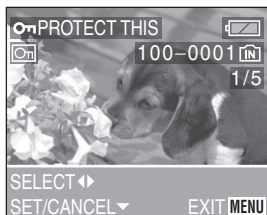

■ Single setting

Select the picture and set/cancel the protection.



SET	The protect icon  appears.
CANCEL	The protect icon  disappears.

■ Multi setting/To cancel all settings

Perform the same operation as in “Setting the Picture to be Printed and the Number of Prints [DPOF PRINT]”. (P73–75)



- If you want to delete protected pictures, cancel the protect setting first.
- While this feature protects the pictures from accidental erasure, formatting the card will permanently delete all data. (P82)
- The protect setting may not be effective in other equipment.
- Sliding the Card Write-Protect switch (A) on the SD Memory Card to [LOCK] prevents the picture from deletion even if the protection is not set.

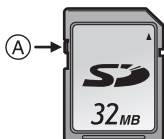

- The following functions cannot be used with protected pictures.
 - [ROTATE] (P72)
 - [AUDIO DUB.] (DMC-LZ2 only) (P77)

▶ Playing Back with Slide Show [SLIDE SHOW]

1 Set the items of the Slide Show.

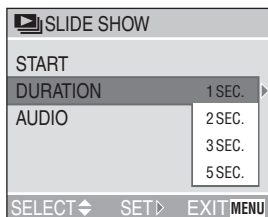

DURATION	It can be set to 1, 2, 3 or 5 seconds.
AUDIO* (DMC-LZ2 only)	By setting it to [ON], the audio of the pictures with audio can be played back during Slide Show.

*When the camera is connected to TV (P84), the audio can be played back.

2 Select [START].

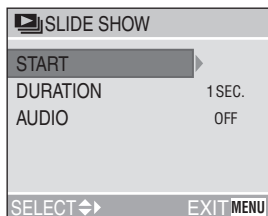

3 By pressing the [MENU] button, the Slide Show stops.

■ SD Slide Show

If you insert a card including the SD Slide Show edited with the [SD Viewer for DSC] which is in the supplied CD-ROM, and then turn the camera on in playback mode, the confirmation screen appears. Select [YES] and press ► to start the SD Slide Show. Select [NO] and press ► to start normal playback.

- Pictures set with the DPOF Slide Show by the [SD Viewer for DSC] cannot be played back as a Slide Show.



- Motion images cannot be played back in the Slide Show.
- When you play back pictures with audio, the next picture appears after the playback of the audio is finished (when [AUDIO] is set to [ON]). (DMC-LZ2 only)

Adding Audio to Recorded Pictures [AUDIO DUB.] (DMC-LZ2 only)

You can record the audio after taking a picture (max. 10 seconds per picture).

1 Select the picture and start audio recording.



- When audio has already been recorded, the confirmation screen appears. Press ▼ to select [YES], and press ► to start audio recording. (The original audio is overwritten.)
- The audio dubbing cannot be used with the following pictures.
 - Motion images
 - Protected pictures

2 Stop audio recording.



- The audio recording stops by pressing the ▼ button.
- Even if you do not press ▼, after about 10 seconds, the audio recording stops automatically.

Resizing the Pictures [RESIZE]

This function is useful if you want to reduce the file size of the picture in cases when it needs to be attached to an e-mail or uploaded to a website.

1 Select the picture and set it.



- The following pictures cannot be resized.
 - Pictures equal to or smaller than 640×480 pixels
 - Pictures recorded after setting the picture size to [HDTV]
 - Motion images
 - Pictures with audio (DMC-LZ2 only)
- It may not be possible to resize pictures recorded with other equipment.

2 Select the size and set it.



- Sizes smaller than the recorded picture are displayed.

- [2048]: 2048×1536 pixels (DMC-LZ2 only)
- [1600]: 1600×1200 pixels
- [1280]: 1280×960 pixels
- [640]: 640×480 pixels

3 Select [YES] or [NO] and set it.



- When you select [YES], the picture is overwritten.
When resized pictures are overwritten, they cannot be restored.
- When the original picture is protected, you cannot overwrite the resized picture.
When you select [NO], a resized picture is newly created.

Trimming the Pictures [TRIMMING]

Use this function when you trim needed parts of the recorded picture.

1 Select the picture to trim and set it.

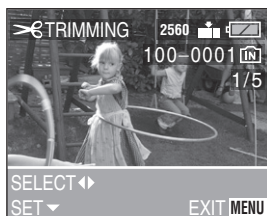

- The following pictures cannot be trimmed.
 - Pictures smaller than 640×480 pixels
 - Pictures recorded after setting the picture size to [HDTV]
 - Motion images
 - Pictures with audio (DMC-LZ2 only)
- It may not be possible to trim pictures recorded with other equipment.

2 Enlarge or decrease the picture.

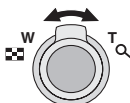

3 Shift the picture and press the shutter button to set.

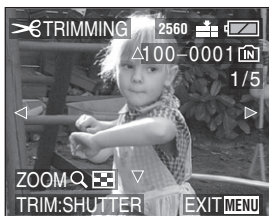

4 Select [YES] or [NO] and set it.

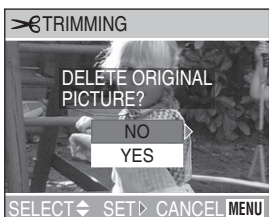

- When you select [YES], the picture is overwritten.
When trimmed pictures are overwritten, they cannot be restored.
- When the original picture is protected, you cannot overwrite the trimmed picture.
When you select [NO], a trimmed picture is newly created.



- Pictures will not be displayed in the rotated direction even if [ROTATE DISP.] is set to [ON]. (P72)
- The picture size of the trimmed pictures may become smaller than that of the original one depending on the cut size.
- The picture quality of the trimmed picture will be deteriorated.

Copying Picture Data [COPY]

Use this function when you want to copy recorded picture data from the built-in memory to the card and vice versa.

1 Select the direction to copy the picture data.

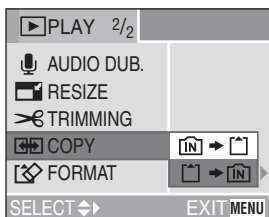

-  \rightarrow :

All pictures are copied from the built-in memory to the card at one time.

(Proceed to step 3.)

-  \rightarrow :

Pictures are copied from the card to the built-in memory one by one.

(Follow the procedure from step 2.)

2 Select pictures to be copied and set them.



- When you copy pictures from the built-in memory to the card, all pictures are selected at one time and this screen does not appear.

3 Select [YES] and set it.

(The illustration is the screen when pictures are copied from the built-in memory to the card.)

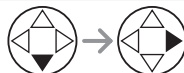
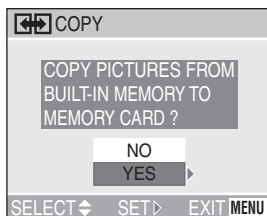

- When you copy pictures from the card to the built-in memory, the message [COPY THIS PICTURE TO BUILT-IN MEMORY?] appears.
- If you turn the camera off or operate for other functions before the copy is completed, the data in the built-in memory or the card may be damaged or lost.



- If you copy the data from the built-in memory to the card, we recommend using a card which has more free space than the built-in memory (about 14 MB).
- If a picture having the same name as the name of picture to be copied exists in the copy destination, the picture will not be copied.
- When you copy the data from the built-in memory to the card and if the free space on the destination recording medium is not sufficient, the picture data can only be copied halfway.
- DPOF settings on the original picture data will not be copied. Set DPOF settings again after the copy is completed. (P73)
- Only files conforming to DCF standard (P49, 75) can be copied. (Files which do not conform to DCF standard cannot be copied.)
- It may take time to copy the data.
- Pictures which are recorded or edited with other equipment may not be copied.

Initializing the Built-in Memory/ the Card [FORMAT]

1 Select [YES] to format the medium.

(The illustration is the screen when the built-in memory is formatted.)

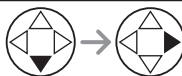
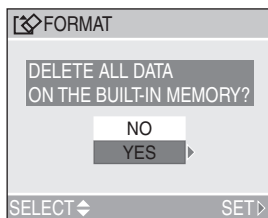

- When a card is not inserted, you can format the built-in memory. When a card is inserted, you can format the card.



- Usually, it is not necessary to format the built-in memory and the card. Format them when the message [BUILT-IN MEMORY ERROR] or [MEMORY CARD ERROR] appears.
- If the built-in memory or the card has been formatted by a PC or other equipment, format it on the camera again.
- **Once the built-in memory or the card is formatted, all data including protected images are irretrievably erased. Please confirm that all data is transferred to your PC before proceeding with format function.**
- During formatting, do not turn the camera off.
- When you format the built-in memory or the card, use batteries with sufficient battery power (P14) or AC adaptor (DMW-AC1; optional).
- When the SD Memory Card Write-Protect switch is slid to [LOCK], you cannot format the card.
- It may take longer to format the built-in memory than the card. (Max. about 15 sec.)
- If the built-in memory or the card cannot be formatted, consult your nearest servicenter.

For USA assistance, please call: 1-800-272-7033
or send e-mail to : digitalstillcam@panasonic.com

For Canadian assistance, please call:
1-800-561-5505 or visit us at www.panasonic.ca

Playing Back Pictures on a TV Screen

■ Playing back pictures with the supplied cable

The procedure for DMC-LZ2 is described below. In the case of DMC-LZ1, connect the TV and the [V.OUT] terminal on the camera with the video cable (supplied).

- Turn the camera and the TV off.

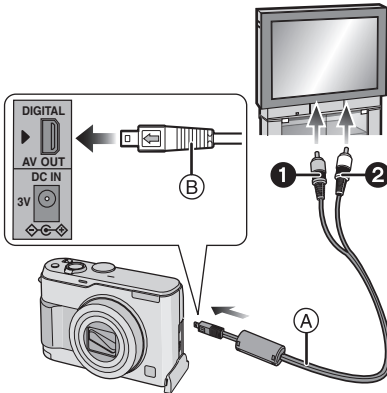

1 Connect the AV cable (A) (supplied) to the [AV OUT] socket of the camera.

- Connect the AV cable with the [←] mark facing the [▶] mark on the [AV OUT] socket.
- Hold the plug (B) to push into or pull out.

2 Connect the AV cable to the video input and the audio input sockets of the TV.

- ① Yellow: to the video input socket
- ② White: to the audio input socket

3 Turn the TV on and select external input.

4 Turn the camera on and then set the mode dial to playback mode [▶].

■ Viewing pictures in other countries

When setting [VIDEO OUT] on the [SETUP] menu, you can view images on the TV in other countries (regions) which use the NTSC or PAL system.

- Even if you set menu selection for [VIDEO OUT] to [PAL], the output signal is still NTSC in the recording mode.

■ Playback pictures on TV with SD Memory Card slot

A recorded SD Memory Card can be played back on TVs with an SD Memory Card slot.

If you play back pictures recorded using [HDTV] mode on a High-Definition TV, (HDTV has 16:9 aspect) the picture quality will be better.

(MultiMediaCard may not be played back on TV with SD Memory Card slot.)



- Do not use any other AV cables (DMC-LZ2)/video cables (DMC-LZ1) except the supplied one.
- Read the TV operating instructions too.
- Audio playback is in monaural. (DMC-LZ2 only)

Before Connecting to the PC or the Printer

[**USB**] : **USB MODE**]

Select the USB communication system before connecting the camera to your PC or your printer with the USB connection cable (supplied).

Set the items on [**USB MODE**] in the [**SETUP**] menu. (P24)



- When [**PC**] is selected, the camera is connected via USB Mass Storage communication system.
- When [**PictBridge (PTP)**] is selected, the camera is connected via PTP (Picture Transfer Protocol) communication system.

1 Select [**USB MODE**].

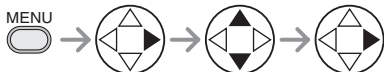
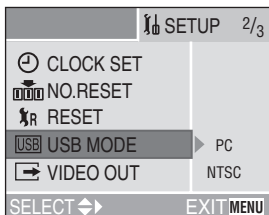

2 Select [**PC**] or [**PictBridge (PTP)**].

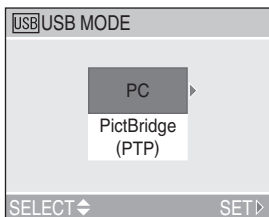

- If you connect the camera to a PC, select [**PC**]. (P86)
- If you connect the camera to a printer supporting PictBridge, select [**PictBridge (PTP)**]. (P88)

Connecting to a PC

If you use Windows® 98/98SE, install the USB driver and then connect it to the computer.

(When using Windows Me/2000/XP, Mac OS 9.x, Mac OS X, you do not have to install the USB driver. Refer to the separate operating instructions about PC connection for the installation of the USB driver.)

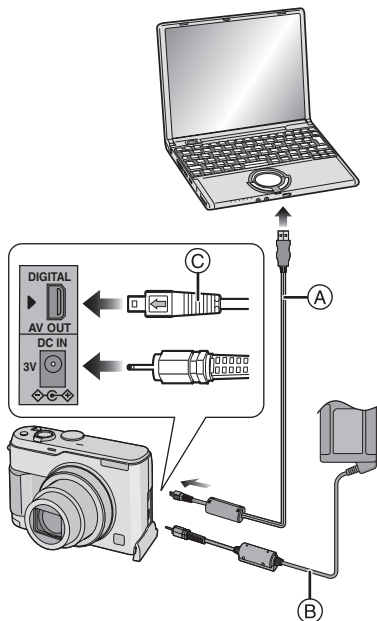

- (A): USB connection cable (supplied)
 (B): AC adaptor (DMW-AC1; optional)

1 Turn the camera on and then set [USB MODE] on the [SETUP] menu to [PC]. (P85)

- If you set [USB MODE] to [PictBridge (PTP)] and then connect the camera to the PC, messages may appear on the screen of the PC.

Select [Cancel] to close the indications and disconnect the camera from the PC. Connect the camera after you set [USB MODE] again.

2 Connect the camera to a PC via the USB connection cable (A) (supplied).

- Connect the USB connection cable with the [←] mark facing the [→] mark on the [DIGITAL] socket.
- Hold the plug (C) to push into or pull out.

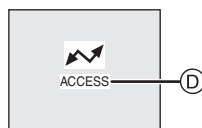

- (D): This message appears during data transfer.

[Windows]

The drive appears on the [My Computer] folder.

- If it is the first time you are connecting the camera to a PC, the required driver is installed automatically so that the camera can be recognized by the Windows Plug and Play, then it appears on the [My Computer] folder.

[Macintosh]

The drive is displayed on the screen.

- When you connect the camera with the card inserted, the drive is shown on the screen as untitled.
- When you connect the camera without the card (with the built-in memory used), the drive is titled as "LUMIX".

■ Folder Composition

The folder structure of the built-in memory, the card or MultiMediaCard is displayed as the illustration below.

- Built-in memory
- SD Memory Card
- MultiMediaCard

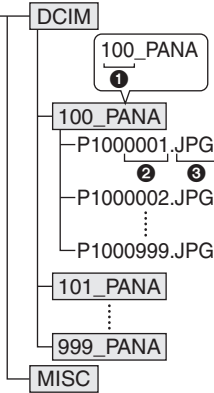

- ❶ Folder number
- ❷ File number
- ❸ JPG: pictures
MOV: motion images

Files will be saved in each folder as follows.

DCIM	Folders from [100_PANA] to [999_PANA]
100_PANA	Pictures/motion images
MISC	Files on which the DPOF print settings are recorded

- When recording, up to 999 picture data can be included in 1 folder. If the number of picture data exceeds 999, another folder will be created.
- When you reset the file number or the folder number, select [NO.RESET] in the [SETUP] menu. (P24)



- If the remaining battery power is exhausted during communication, the recorded data may be damaged. When you connect the camera to the PC, use batteries with sufficient battery power (P14) or the AC adaptor (DMW-AC1; optional).

- If the remaining battery power becomes low during communication, the status indicator blinks and the alarm beeps. In this case, stop the communication at once.
- While [ACCESS] is being displayed, do not disconnect the USB connection cable.
- **When the OS of your PC is Windows 2000 and you connect the camera to the PC with the USB connection cable, do not replace the card with the camera connected to the PC. The information in the card may be damaged.**
- Do not use any other USB connection cables except the supplied one.
- For more information, refer to the separate operating instructions about PC connection.
- Also refer to the operating instructions of the PC.
- If the card is not inserted when the camera is connected to a PC, you can edit or access the picture data in the built-in memory. If the card is inserted, you can edit or access the picture data in it.
- You cannot switch the recording medium between the built-in memory and the card while the camera is connected to the PC. When you want to switch the recording medium, disconnect the USB connection cable, insert (or remove) the card and then connect the USB connection cable to the PC again.

■ PictBridge (PTP) setting

Even if you set the [USB MODE] to [PictBridge (PTP)], you can connect to the PC only when the OS is Windows XP Home Edition, Windows XP Professional or Mac OS X.

- You can only load pictures from the camera and cannot write them on the card or delete them.
- When there are 1000 or more pictures on a card, the pictures may not be imported.

Connecting to a PictBridge-compliant Printer

By connecting the camera directly to a printer supporting PictBridge via the USB connection cable (supplied), you can select the pictures to be printed or start printing on the LCD monitor.

Set the print settings such as print quality on the printer beforehand. (Read the printer operating instructions.)

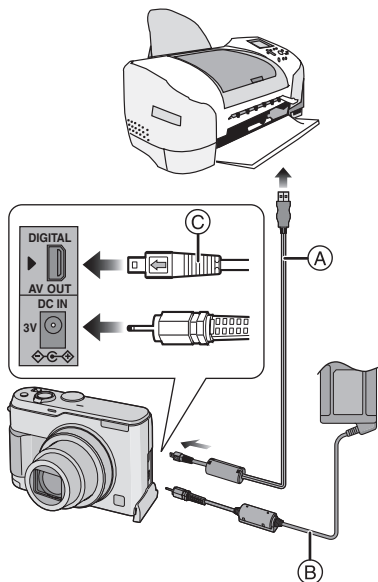

- (A) USB connection cable (supplied)
 (B) AC adaptor (DMW-AC1; optional)

1 Turn the camera on and then set [USB MODE] on the [SETUP] menu to [PictBridge (PTP)]. (P85)

2 Turn on the printer.

3 Connect the camera to a printer via the USB connection cable (A) (supplied).

- Connect the USB connection cable with the [←] mark facing the [▶] mark on the [DIGITAL] socket.
- Hold the plug (C) to push into or pull out.

When the DPOF Print is not set.	Select [SINGLE PICTURE]. (P89)
When the DPOF Print is set. (P73)	Select [DPOF PICTURE]. (P90)



- It may take time to print some pictures. Therefore, use batteries with sufficient battery power (P14) or the AC adaptor (DMW-AC1; optional) when you connect to a printer.
- If the remaining battery power becomes low during communication, the status indicator blinks and the alarm beeps. In this case, stop the communication at once.
- Disconnect the USB connection cable after printing.
- Do not use any other USB connection cables except the supplied one.
- If the card is not inserted when the camera is connected to a printer, you can edit or access the picture data in the built-in memory. If the card is inserted, you can edit or access the picture data in it.
- You cannot switch the recording medium between the built-in memory and the card while the camera is connected to the printer. When you want to switch the recording medium, disconnect the USB connection cable, insert (or remove) the card and then connect the USB connection cable to the printer again.

■ Single picture

1 Select a picture to be printed.

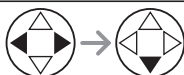
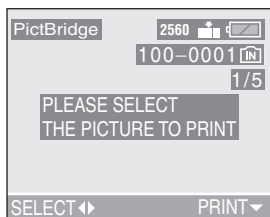

- A message disappears in about 2 seconds.

2 Set the print settings.

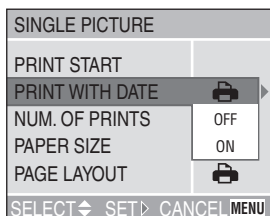

- The items which are not supported by the printer are displayed in gray and cannot be selected.
- When you want to print pictures in a paper size or a layout which is not supported by the camera, set [PAPER SIZE] or [PAGE LAYOUT] to [] and then set the paper size or the layout on the printer. (For details, refer to the operating instructions of the printer.)

• [PRINT WITH DATE]

	Settings on the printer are prioritized.
OFF	Date is not printed.
ON	Date is printed.

- If the printer does not support date printing, the date cannot be printed on the picture.

• [NUM. OF PRINTS]

Set the number of prints.

• [PAPER SIZE]

(Possible paper sizes on the camera)





The items are listed on 1/2 and 2/2. Press ▼ to select the desired item.

1/2	
	Settings on the printer are prioritized.
L/3.5"×5"	89 mm×127 mm
2L/5"×7"	127 mm×178 mm
POSTCARD	100 mm×148 mm
A4	210 mm×297 mm
2/2*	
CARD SIZE	54 mm×85.6 mm
10×15cm	100 mm×150 mm
4"×6"	101.6 mm×152.4 mm
8"×10"	203.2 mm×254 mm
LETTER	216 mm×279.4 mm

- *These items cannot be displayed when the printer does not support the paper sizes.

- **[PAGE LAYOUT]**

(Possible layouts on the camera)

	Settings on the printer are prioritized.
	1 page with no frame print
	1 page with frame print
	2 pages print
	4 pages print

3 Select [PRINT START] and then print out the picture.

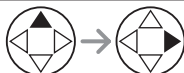
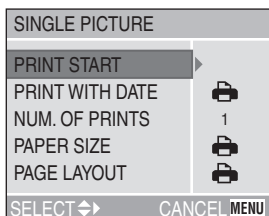

- Press the [MENU] button to cancel printing.

- **DPOF picture**

- Set the DPOF print with the camera in advance. (P73)

1 Select [DPOF PICTURE].

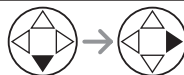
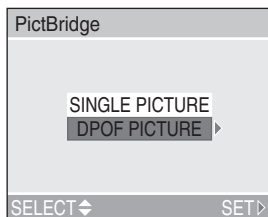

- When printing under the new settings, disconnect the USB connection cable and connect it to the printer again.
- You can change the DPOF print setting by pressing the [MENU] button. (P73)

2 Select [PRINT START] and then print out the picture.

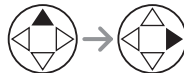
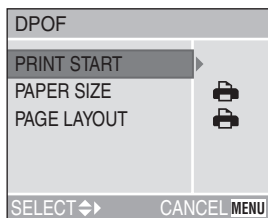

- Refer to P89 for printing setting.
- Press the [MENU] button to cancel printing.

■ Setting the date printing with the DPOF print in advance

When the printer supports the date printing by DPOF setting, we recommend setting the date printing with the DPOF print in advance. (P74) The recording date can be printed by selecting [DPOF PICTURE] to start printing.



- Do not disconnect the USB connection cable when the cable disconnection warning icon [⚠] is indicated.
- When the [●] indication lights in orange during printing, the camera is receiving an error message from the printer. Make sure there is no malfunction on the printer after finishing printing.
- In DPOF print, if the total number of prints or the number of printed pictures is high, pictures may be printed several times. (The indication of the remaining number of prints is different from the setting, however, this is not a malfunction.)
- The setting on the printer may have priority over the setting on the camera in the date print. Also check the date print setting on the printer.
- If the printer does not support date printing, the date cannot be printed on the picture.

■ Layout printing

• When printing a picture several times on 1 sheet of paper

For example, if you want to print a picture 4 times on 1 sheet of paper, set [PAGE LAYOUT] to [4x4] and then set the number of prints to 4 for the picture on [NUM. OF PRINTS].

• When printing different pictures on 1 sheet of paper (only in DPOF printing)

For example, if you want to print 4 different pictures on 1 sheet of paper, set [PAGE LAYOUT] to [4x4] and then set the number of prints to 1 on [COUNT] in DPOF print setting (P73) for each of the 4 pictures.

Screen Display

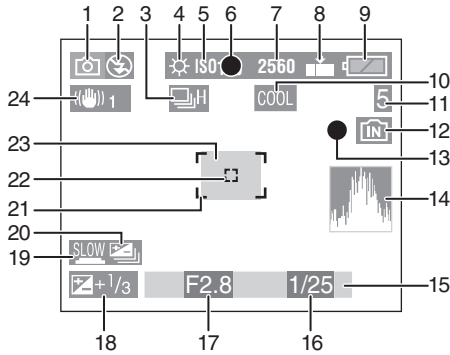

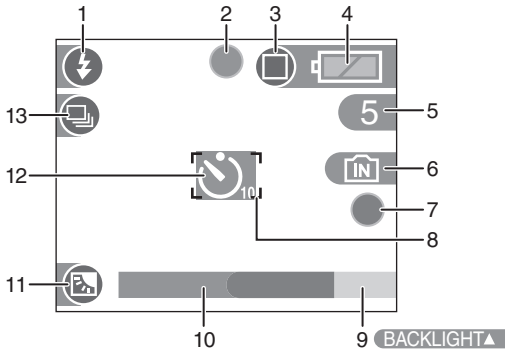

■ In recording

- 1 Recording mode
- 2 Flash mode (P40)
- 3 Burst (P47)
 - 📷: Audio recording (DMC-LZ2 only) (P55, 66)
- 4 White balance (P63)
- 5 ISO sensitivity (P65)
- 6 Focus (P31)
- 7 Picture size (P65)
- 8 Quality (P66)
 - 📷: Jitter alert (P33)
- 9 Battery indication (P14)
- 10 Color effect (P69)
- 11 Picture/Time remain
 - In Motion image mode: e.g. 11S
- 12 Built-in memory/card (P20)
 - 📷: Built-in memory
 - 📷: Card
- 13 Recording state
- 14 Histogram (P29)
- 15 Current date and time (P23)
 - This is displayed for about 5 seconds when turning the camera on, setting the clock and after switching from the playback mode to the recording mode.
- Zoom/Digital zoom (P39, 68)
 - W [Progress Bar] T 20X
- 16 Shutter speed (P31)
- 17 Aperture value (P31)
- 18 Exposure compensation (P44)
- 19 Slow shutter (P68)
- 20 Auto bracket (P45)
- 21 AF area (P31)
- 22 Spot AF area (P67)
- 23 Self-timer (P43)
 - 🕒
- 24 Optical image stabilizer (P46)



■ Recording in simple mode

- 1 Flash mode (P40)
- 2 Focus (P31)
- 3 Picture mode (P35)
: Jitter alert (P33)
- 4 Battery indication (P14)
- 5 Pictures remaining
- 6 Built-in memory/card (P20)
: Built-in memory
: Card
- 7 Recording state
- 8 AF area (P31)
- 9 Operation for backlight compensation (P37)

- 10 Current date and time (P23)
 - This is displayed for about 5 seconds when turning the camera on, setting the clock and after switching from the playback mode to the simple mode.

Zoom (P39)



- 11 Backlight compensation (P37)
- 12 Self-timer (P43)
- 13 Burst (P47)

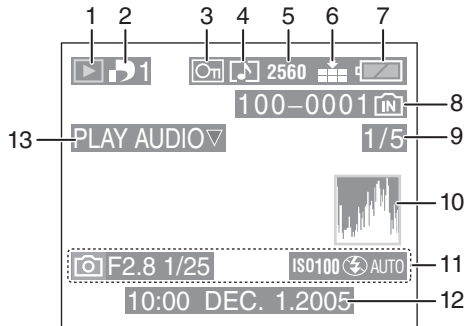

■ In playback

- 1 Playback mode
- 2 Number of DPOF prints (P73)
- 3 Protected picture (P75)
- 4 Picture with audio (DMC-LZ2 only) (P70)
- 5 Picture size (P65)
 : In Motion image mode
- 6 Quality (P66)
 / : In Motion image mode (P55)
 Simple mode (P35):
 : ENLARGE
 : 4"×6"/10×15cm
 : E-MAIL
- 7 Battery indication (P14)
- 8 Folder number, file number (P87), built-in memory/card (P20)
- 9 Page number/Total pictures
- 10 Histogram (P29)
 • It will be displayed when the [DISPLAY] button is pressed.
- 11 Recording information (Recording mode/Aperture value/ Shutter speed/ISO sensitivity/Flash mode/White balance)
 • It will be displayed when the [DISPLAY] button is pressed.
- 12 Recorded date and time
- 13 Audio playback (DMC-LZ2 only) (P70)
 : In Motion image mode

Cautions for Use

■ Optimal Use of the Camera

When carrying the camera, take care not to drop or cause impact to it.

- The lens or the outer case may be destroyed by the strong shock, and it causes a malfunction of the camera.

Keep the camera away from magnetized equipment (such as a microwave oven, TV, video game equipment, etc.).

- If you use the camera on or near a TV, pictures and sounds may be disrupted due to electromagnetic wave radiation.
- Do not use the camera near a cell phone because doing so may cause noise to adversely affect the pictures and sounds.
- Recorded data may be damaged, or pictures may be distorted by strong magnetic fields created by speakers or large motors.
- Electromagnetic wave radiation generated by a microprocessor may adversely affect the camera, causing the disturbance of pictures and sounds.
- If the camera is affected by magnetically charged equipment and does not function properly, turn the camera off and remove the batteries or disconnect AC adaptor (DMW-AC1; optional) and then insert the batteries or connect AC adaptor again. Thereafter, turn the camera on.

Do not use the camera near radio transmitters or high-voltage lines.

- If you record near radio transmitters or high-voltage lines, recorded pictures or sounds may be adversely affected.

Make sure to use the supplied cords and cables. If you use optional accessories, use the cords and the cables supplied with them.

Do not extend the cords and the cables.

Do not spray insecticides or volatile chemicals onto the camera.

- If the camera is sprayed with such chemicals, the camera body may be damaged and the surface finish may peel off.
- Do not keep rubber or plastic products in contact with the camera for a long period of time.

Do not use benzine, thinner or alcohol for cleaning the camera.

- When cleaning the camera, remove the batteries or disconnect the AC adaptor (DMW-AC1; optional) from the electrical outlet.
- The camera body may be deformed and the surface finish may peel off.
- Wipe the camera with a soft, dry cloth. To remove stubborn stains, wipe with a cloth that is soaked in a detergent diluted with water and afterward finish wiping with a dry cloth.
- If you use a chemical cloth, follow the instructions that come with the cloth.
- In case rain or other sources of water splash onto the camera, wet a soft cloth with tap water, wring it well, and use it to wipe the camera body carefully. Then wipe it again with a dry cloth.

■ Card

Do not leave the card in places where there is high temperature or direct sunlight, or where electromagnetic waves or static electricity are easily generated.

Do not bend or drop the card.

- The card may be damaged or the recorded content may be damaged or erased.
- Store the card in the card case or the storage bag after use and when you store or carry the card.
- Do not allow dirt, dust or water to enter the terminals on the back of the card and do not touch the terminals with your fingers.

■ Batteries

When you will not be using the camera for a long period of time, be sure to remove the batteries.

- If the batteries are left in extremely high or low temperatures, the terminals may rust and cause malfunctions.

If you drop the batteries accidentally, check to see if the battery body and terminals are damaged.

- Inserting a damaged battery in the camera will damage the camera.

When you go out, bring spare batteries.

- Be aware that the operating time of the batteries will become shorter in low temperatures such as outdoors at a ski resort.

Dispose of unusable batteries.

- The batteries have a limited life.
- Do not throw the batteries into fire because they may cause an explosion.
- Unusable batteries should be discarded in accordance with battery recycling laws. For information you can call the RBRC hotline at 1-800-822-8837.

Do not allow the battery terminals to come in contact with metal objects (such as necklaces, hairpins, etc.).

- This can result in a short circuit or heat generation and, if you touch the battery in this condition, you may be badly burned.

Message Display

Confirmation messages or error messages will be displayed on the LCD monitor in some cases.

Major messages are described below as examples.

[CURRENT BATTERY TYPE SETTING: OXYRIDE]/[CURRENT BATTERY TYPE SETTING: ALKALINE/Ni-MH]

If the type of batteries in use is different from the one indicated in the message, select the type of batteries on [BATTERY TYPE] in the [SETUP] menu. (P24)

[THIS MEMORY CARD IS PROTECTED]

Unlock [LOCK] of the Write-Protect switch on the SD Memory Card. (P20)

[NO VALID IMAGE TO PLAY]

Play back after recording or after inserting a card with a recorded picture.

[THIS PICTURE IS PROTECTED]

After canceling the protect setting, delete or overwrite the picture.

[THIS PICTURE CANNOT BE DELETED]/[SOME PICTURES CANNOT BE DELETED]

The pictures not based on the DCF standard cannot be deleted.

[CANNOT BE SET ON THIS PICTURE]/[CANNOT BE SET ON SOME PICTURES]

If the pictures are not based on the DCF standard, the DPOF print cannot be set.

[NO ADDITIONAL DELETE SELECTIONS CAN BE MADE]

You have exceeded the number of pictures that can be set at once with [MULTI DELETE]. Once delete the selected pictures and then repeat deleting multiple pictures.

[NOT ENOUGH SPACE ON BUILT-IN MEMORY]/[NOT ENOUGH MEMORY IN THE CARD]

There is no space left on the built-in memory or the memory card.

- When you copy pictures from the built-in memory to the memory card (batch copy), the pictures are copied until the capacity of the card becomes full.

[SOME PICTURES CANNOT BE COPIED]/[COPY COULD NOT BE COMPLETED]

Pictures described below cannot be copied.

- When there is a picture with the same name as the picture you want to copy on the copy destination.
- Files which do not comply with DCF standard

Moreover, pictures recorded or edited by other equipment may not be copied.

[BUILT-IN MEMORY ERROR FORMAT BUILT-IN MEMORY?]

This message will be displayed when you format the built-in memory on the PC or remove the batteries without turning the camera off. Format the built-in memory on the camera again. The data on the built-in memory will be deleted.

**[MEMORY CARD ERROR
FORMAT THIS CARD?]**

The format of the card cannot be recognized by the camera. Format the card again with the camera.

**[PLEASE TURN CAMERA OFF AND
THEN ON AGAIN]**

This message appears when the camera does not operate properly. Turn the camera off and on. If the message persists, contact the dealer or your nearest servicerenter.

[MEMORY CARD ERROR]

Failed access to the card.
Insert the card again.

[READ ERROR]

Data reading error.
Play it back again.

[WRITE ERROR]

Data writing error.
Turn the camera off and remove the card.
Then insert the card and turn the camera on again. Be sure that the camera is turned off before removing or inserting the card to avoid damage.

Troubleshooting

If you put the menu back to the settings at the time of purchase, the conditions may be improved.

Carry out the [RESET] in the [SETUP] menu. (P24)

■ Batteries and the power source

1: The camera is turned off immediately even when the battery power is full.

The battery indication shows less than the actual remaining battery power even if new batteries are inserted.

- Is [BATTERY TYPE] selected correctly?
 - Select the item on [BATTERY TYPE] in the [SETUP] menu. (P24)

2: The camera cannot be operated even when it is turned on.

- Are the batteries inserted correctly?
- Use batteries that have been sufficiently charged when you use Ni-MH batteries.

3: The LCD monitor is turned off even when the camera is turned on.

- Is the power save mode (P24) or economy mode (P54) activated?
 - Press the shutter button halfway to cancel these modes.
- Are the batteries exhausted?
 - Replace them with batteries which have enough capacity. (When you use Ni-MH batteries, charge them.)

4: The LCD monitor is turned off sometimes when the camera is turned on.

- Is the LCD monitor turned off soon after you take pictures with the flash?
 - While the flash is being charged, the LCD monitor is turned off.

5: The camera is turned off immediately even after it is turned on.

- Are the batteries exhausted?
 - Replace them with batteries which have enough capacity. (When you use Ni-MH batteries, charge them.)
 - If you leave the camera with turning it on, the batteries are exhausted. Turn the camera off frequently by using the economy mode (P54), the power save mode (P24), etc.

■ Recording

1: The picture cannot be recorded.

- Is the mode dial correctly set?
- Is there any memory capacity left on the built-in memory or the card?
 - Before recording, delete some pictures.

2: The subject is not focused properly.

- The focus range varies depending on the recording mode.
 - Rotate the mode dial to set to the proper mode for the distance to the subject.
- Is the subject out of the focus range? (P33)
- When you cannot focus on the subject even if you tried many times, turn the camera off once and turn it on again.

3: The recorded picture is blurred.

- When taking a picture in shaded areas or indoors, the shutter speed becomes slow and the optical image stabilizer function may not work properly. In this case, we recommend holding the camera with both hands firmly to take pictures. When the [SLOW SHUTTER] (P68) is set, we recommend using a tripod.

■ LCD monitor

1: The brightness of the screen

becomes dark or bright for a moment.

- This phenomenon appears when pressing the shutter button halfway to set the aperture value and does not affect the recorded pictures.

2: The screen is too bright or dark.

- Adjust the brightness of the screen.

3: Some pixels are inactive or always lit on the LCD monitor.

- These pixels do not affect the recorded pictures.
This is not a malfunction.

4: Noise appears on the LCD monitor.



- In dark places, noise may appear to maintain the brightness of the LCD monitor.
This does not affect the pictures you are recording.

5: A vertical red line appears on the LCD monitor.

- This is called smear. It is specific to CCD, not a malfunction. It appears when the subject has a bright part. It is recorded on motion images, but not recorded on still pictures.

■ Flash

1: Flash is not activated.

- Is the flash setting set to Forced OFF [?
– Change the flash setting. (P40)
- The flash is not activated when in motion image mode [], [SCENERY], [NIGHT SCENERY], or [FIREWORKS] in scene mode (P57) is selected.

2: The flash is activated 2 times.

- When you select AUTO/Red-eye reduction [], the first flash is activated for red-eye prevention on the subject (red-eye phenomenon) before actually recording pictures. After the first flash, the flash is activated again for recording.

■ Playback

1: Pictures being played are rotated and displayed in an unexpected direction.

The camera has a function to automatically rotate and display pictures recorded by holding the camera vertically.

(If you take pictures aiming the camera up or down, the camera may recognize that it is held vertically.)

- When [ROTATE DISP.] (P72) is set to [OFF], you can display the pictures without being rotated.
- You can rotate pictures with [ROTATE] function (P72).

2: The picture is not played back.

- Is the mode dial set to playback [?]
- Is there a picture in the built-in memory or the card?
When a card is not inserted, the picture data in the built-in memory appear.
When a card is inserted, the picture data in the card appear. (P20)

3: The picture played back looks rough. Noise appears on the picture.

- Is the ISO sensitivity is high or is the shutter speed slow?
– Decrease the ISO sensitivity. (P65)
– Set [PICT.ADJ.] to [NATURAL]. (P69)
– Take pictures in bright places.
-

■ TV, PC and printer

1: The picture does not appear on the television.

- Is the camera connected to the TV correctly?
- Set the TV input to external input mode.

2: When connecting to a PC, pictures cannot be transferred.

- Is the camera connected to the PC correctly?
- Is the camera recognized by the PC correctly?
- Set [USB MODE] to [PC]. (P85)

3: The card is not recognized by the PC. (The built-in memory is recognized.)

- Disconnect the USB connection cable and then connect it again with the card inserted into the camera.

4: The pictures cannot be printed with the camera connected to printers.

- Is the printer supporting PictBridge?
 - You cannot print pictures with printers which do not support PictBridge (P88).
- Set [USB MODE] to [PictBridge (PTP)]. (P85)

5: Both ends of the picture recorded by setting the picture size to [HDTV] (1920×1080 pixels) are cut out.

- When you order photo studios to print pictures, ask the photo studio if the pictures can be printed with both ends.
 - When using the printer with a trimming feature or other feature which cuts out both edges of the pictures, cancel the feature for printing. The feature depends on the printer used.
 - Refer to the operating instructions of the printer for details.
-

■ Others

1: Unreadable language was selected by mistake.

- Press the [MENU] button and select [] icon on the [] SETUP menu to set the desired language.

2: The setting for the auto review function is disabled.

- Is the camera in burst mode (P47), auto bracket (P45) or motion image mode [] (P55), or is [AUDIO REC.] set to [ON] (DMC-LZ2 only) (P66)?
 - In these cases, you cannot set the auto review function in the [SETUP] menu.

3: The lens clicks.

- When brightness has changed due to the zoom or the movement of the camera or other, the lens may click and the picture on the screen may be drastically changed, however, the pictures are not affected. The sound is caused by automatic adjustment of the aperture. It is not a malfunction.

4: The clock setting is reset.

- If you do not use the camera for a long time, the clock setting may be reset. When the message [PLEASE SET THE CLOCK] appears, set the clock again.
- When you take a picture before setting the clock, [0:00 0. 0. 0] is recorded.

5: Colors that were actually not around the subject appear on the picture.

- On the camera, color shift may appear by the characteristic of the lens. This is not a malfunction.
-

Specifications

Digital Camera: Information for your safety





Power Source:	DC 3.0 V
Power Consumption:	DMC-LZ2: 1.4 W (When recording) 0.7 W (When playing back)
	DMC-LZ1: 1.5 W (When recording) 0.7 W (When playing back)

Camera Effective pixels:	DMC-LZ2: 5,000,000 pixels DMC-LZ1: 4,000,000 pixels
Image sensor:	1/2.5" CCD, total pixel number 5,360,000 pixels (DMC-LZ2)/ 4,230,000 pixels (DMC-LZ1) Primary color filter
Lens:	Optical 6× zoom, f=6.1–36.6 mm (35 mm film camera equivalent: 37–222 mm)/F2.8–4.5
Digital zoom:	Max. 4×
Focus:	Normal/Macro, 5-area-focusing/3-area-focusing/ 1-area-focusing/Spot-focusing
Focus range:	1.64 feet (50 cm) (Wide)/3.94 feet (1.2 m) (Tele)–∞ Macro/Simple: 0.16 feet (5 cm) (Wide)/1.64 feet (50 cm) (Tele)–∞
Shutter system:	Electronic shutter+Mechanical shutter
Burst recording	
Burst speed:	DMC-LZ2: 3 frames/second (high speed), 2 frames/second (low speed), Approx. 1.5 frames/second (unlimited) DMC-LZ1: 4 frames/second (high speed), 2 frames/second (low speed), Approx. 1.5 frames/second (unlimited)
Number of recordable pictures:	DMC-LZ2: Max. 5 frames (Standard), max. 3 frames (Fine), DMC-LZ1: Max. 7 frames (Standard), max. 4 frames (Fine), Depends on the remaining capacity of the built-in memory or the card. (unlimited) (Performance in burst recording is only with SD Memory Card. MultiMediaCard performance will be less.)
Motion image recording:	320×240 pixels (30 or 10 frames/second with audio. The maximum recording time depends on the capacity of the built-in memory or the card. Audio recording is available only with DMC-LZ2.)
ISO sensitivity:	DMC-LZ2: AUTO/80/100/200/400 DMC-LZ1: AUTO/64/100/200/400
Shutter speed:	8–1/2,000th Motion image mode: 1/30th–1/2,000th
White balance:	AUTO/Daylight/Cloudy/Halogen/White set
Exposure (AE):	Program AE Exposure compensation (1/3 EV Step, –2–+2 EV)
Metering mode:	Multiple
LCD monitor:	2.0" TFT LCD (85,000 pixels) (field of view ratio about 100%)

102

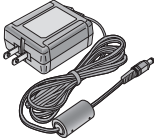
Flash:	Flash range: (ISO AUTO) Approx. 0.98 feet (30 cm) – 13.8 feet (4.2 m) (Wide) AUTO, AUTO/Red-eye reduction, Forced ON (Forced ON/ Red-eye reduction), Slow sync./Red-eye reduction, Forced OFF
Microphone:	Monaural (DMC-LZ2)
Recording media:	Built-in Memory/SD Memory Card/MultiMediaCard
Picture size:	2560×1920 pixels (DMC-LZ2), 2304×1728 pixels (DMC-LZ1), 2048×1536 pixels (DMC-LZ2), 1600×1200 pixels, 1280×960 pixels, 640×480 pixels, 1920×1080 pixels (Still picture) 320×240 pixels (Motion image)
Quality:	Fine/Standard
Recording file format	
Still Picture:	JPEG (Design rule for Camera File system, based on Exif 2.2 standard)/DPOF corresponding
Picture with audio (DMC-LZ2):	JPEG (Design rule for Camera File system, based on Exif 2.2 standard)+640×480 pixels QuickTime (picture with audio)
Motion images:	QuickTime Motion JPEG (Audio recording is available on DMC-LZ2.)
Interface	
Digital:	USB 2.0 (Full Speed)
Analog video/audio:	NTSC/PAL Composite (Switched by menu), Audio line output (monaural) (DMC-LZ2)
Terminal	
DIGITAL/AV OUT (DMC-LZ2):	
DIGITAL/V.OUT (DMC-LZ1):	Dedicated jack (8 pin)
DC IN:	type 1 jack
Dimensions:	3 15/16" (W)×2 1/2" (H)×1 5/16" (D) (100.5 mm (W)×63.5 mm (H)×32.9 mm (D)) (excluding the projection part)
Weight:	Approx. 6.28 oz/178 g (excluding Memory Card and batteries) Approx. 7.90 oz/224 g (with batteries)
Operating Temperature:	32°F – 104°F (0°C – 40°C)
Operating Humidity:	10% – 80%

Digital Camera Accessory System

Accessory#	Figure	Description
DMW-AC1		AC Adaptor
RP-SDK01GU1A RP-SDK512U1A RP-SDH256U1A RP-SD128BU1A RP-SD064BPPA RP-SD032BPPA		1 GB SD Memory Card 512 MB SD Memory Card 256 MB SD Memory Card 128 MB SD Memory Card 64 MB SD Memory Card 32 MB SD Memory Card
BN-SDCAPU/1B		SD USB Reader/Writer (compatible with MultiMediaCard)
BN-SDABPU/1B		SD PC Card Adaptor (compatible with MultiMediaCard)

* NOTE: Accessories and/or model numbers may vary by country. Please consult your local dealer.

Digital Camera Accessory Order Form

(For USA Customers)

Please photocopy this form when placing an order.

1. Digital Camera Model # _____

2. Items Ordered

Accessory #	Description	Price Each	Quantity	Total Price
Subtotal				
Your State & Local Sales Tax				
Shipping & Handling				6.95
Total Enclosed				

3. Method of payment (check one)

- Check of Money Order enclosed (NO C.O.D.SHIPMENTS)
- VISA Credit Card # _____
- MasterCard Expiration Date _____
- Discover Customer Signature _____

Make Check or Money Order to: PANASONIC ACCESSORIES

(Please do not send cash)

4. Shipping information (UPS delivery requires complete street address)

Ship To:

Mr.

Mrs.

Ms.

First _____ Last _____

Phone#:

Day () _____

Street Address _____

Night () _____

City _____ State _____ Zip _____

TO OBTAIN ANY OF OUR DIGITAL CAMERA ACCESSORIES YOU CAN DO ANY OF THE FOLLOWING:

VISIT YOUR LOCAL PANASONIC DEALER

OR

CALL PANASONIC'S ACCESSORY ORDER LINE AT 1-800-332-5368

[6 AM-5 PM M-F, 6 AM-10:30 AM SAT, PACIFIC TIME]

OR

MAIL THIS ORDER TO: PANASONIC SERVICES COMPANY ACCESSORY ORDER OFFICE

20421 84th Avenue South Kent, WA. 98032

In CANADA, please contact your local Dealer for more information on Accessories.

Request for Service Notice (For USA Only)

Please photocopy this form when making a request for service notice.

In the unlikely event this product needs service.

- Request for Service Notice:**
- (USA Only)**
- Please include your **proof of purchase.**
(Failure to do so will delay your repair.)
 - To further speed your repair, please provide an explanation of what wrong with the unit and any symptom it is exhibiting.
-
-
-
-

Mail this completed form and your Proof of Purchase along with your unit to:

Panasonic Services Company
1705 N. Randall Road
Elgin, IL. 60123-7847
Attn: Digital Camera Repair

Limited Warranty (For USA Only)

PANASONIC CONSUMER
ELECTRONICS COMPANY,
DIVISION OF PANASONIC
CORPORATION OF NORTH
AMERICA

One Panasonic Way, Secaucus, New
Jersey 07094

PANASONIC PUERTO RICO, INC.
Ave. 65 de Infantería, Km. 9.5, San
Gabriel Industrial Park, Carolina,
Puerto Rico 00985

Panasonic Digital Still Camera Limited Warranty

Limited Warranty Coverage

If your product does not work properly because of a defect in materials or workmanship, Panasonic Consumer Electronics Company or Panasonic Puerto Rico, Inc. (collectively referred to as “the warrantor”) will, for the length of the period indicated on the chart below, which starts with the date of original purchase (“warranty period”), at its option either (a) repair your product with new or refurbished parts, or (b) replace it with a new or refurbished product. The decision to repair or replace will be made by the warrantor.

PRODUCT OR PART NAME	PARTS	LABOR
DIGITAL STILL CAMERA (EXCEPT ITEMS LISTED BELOW)	1 (ONE) YEAR	90 (NINETY) DAYS
CCD	6 (SIX) MONTHS	90 (NINETY) DAYS
RECHARGEABLE BATTERY PACK (IN EXCHANGE FOR DEFECTIVE BATTERY PACK)	90 (NINETY) DAYS	NOT APPLICABLE
SD MEMORY CARD (IN EXCHANGE FOR DEFECTIVE SD CARD)	90 (NINETY) DAYS	NOT APPLICABLE

During the “Labor” warranty period there will be no charge for labor. During the “Parts” warranty period, there will be no charge for parts. You must carry-in or mail-in your product during the warranty period. If non-rechargeable batteries are included, they are not warranted. This warranty only applies to products purchased and serviced in the United States or Puerto Rico. This warranty is extended only to the original purchaser of a new product which was not sold “as is”. A purchase receipt or other proof of the original purchase date is required for warranty service.

Carry-In or Mail-In Service

For Carry-In or Mail-In Service in the United States call
1-800-272-7033.

For assistance in Puerto Rico call Panasonic Puerto Rico, Inc.
(787)-750-4300 or fax (787)-768-2910.

This warranty **ONLY COVERS** failures due to defects in materials or workmanship, and **DOES NOT COVER** normal wear and tear or cosmetic damage. The warranty **ALSO DOES NOT COVER** damages which occurred in shipment, or failures which are caused by products not supplied by the warrantor, or failures which result from accidents, misuse, abuse, neglect, mishandling, misapplication, alteration, faulty installation, set-up adjustments, misadjustment of consumer controls, improper maintenance, power line surge, lightning damage, modification, or commercial use (such as in a hotel, office, restaurant, or other business), rental use of the product, service by anyone other than a Factory Servicenter or other Authorized Servicer, or damage that is attributable to acts of God.

THERE ARE NO EXPRESS WARRANTIES EXCEPT AS LISTED UNDER “LIMITED WARRANTY COVERAGE”. THE WARRANTOR IS NOT LIABLE FOR INCIDENTAL OR CONSEQUENTIAL DAMAGES RESULTING FROM THE USE OF THIS PRODUCT, OR ARISING OUT OF ANY BREACH OF THIS WARRANTY. (As examples, this excludes damages for lost time, travel to and from the servicer, loss of media or images, data or other memory content. The items listed are not exclusive, but are for illustration only.) **ALL EXPRESS AND IMPLIED WARRANTIES, INCLUDING THE WARRANTY OF MERCHANTABILITY, ARE LIMITED TO THE PERIOD OF THE LIMITED WARRANTY.**

Some states do not allow the exclusion or limitation of incidental or consequential damages, or limitations on how long an implied warranty lasts, so the exclusions may not apply to you.

This warranty gives you specific legal rights and you may also have other rights which vary from state to state. If a problem with this product develops during or after the warranty period, you may contact your dealer or Servicenter. If the problem is not handled to your satisfaction, then write to the warrantor's Consumer Affairs Department at the addresses listed for the warrantor.

PARTS AND SERVICE WHICH ARE NOT COVERED BY THIS LIMITED WARRANTY ARE YOUR RESPONSIBILITY.

Customer Services Directory (For USA Only)

For Product Information, Operating Assistance, Literature Request, Dealer Locations, and all Customer Service inquiries please contact:

1-800-272-7033, Monday-Friday 8:30am-8pm EST.

Web Site: <http://www.panasonic.com/consumersupport>

You can purchase parts, accessories or locate your nearest servicer by visiting our Web Site.

Accessory Purchases:

Purchase Parts, Accessories and Instruction Books online for all Panasonic Products by visiting our Web Site at:

<http://www.pasc.panasonic.com>

or, send your request by E-mail to:

npcparts@us.panasonic.com

You may also contact us directly at:

1-800-332-5368 (Customer Orders Only)

Panasonic Services Company 20421 84th Avenue South, Kent, WA 98032

(6 am to 5 pm Monday - Friday; 6 am to 10:30 am Saturday; PST)

(Visa, MasterCard, Discover Card, American Express, Check)

Product Repairs

Centralized Factory Servicer

Panasonic Services Company

1705 N. Randall Road,

Elgin, IL 60123-7847

Attention: Digital Camera Repair

MAIL TO :

Please carefully pack and ship, prepaid and insured, to the Elgin Centralized Factory Servicer.

Customer's in Puerto Rico, please ship or carry in to location below ("Service in Puerto Rico").

Service in Puerto Rico

Panasonic Puerto Rico, Inc.:

Ave. 65 de Infantería, Km. 9.5, San Gabriel Industrial Park, Carolina, Puerto Rico 00985

Phone (787) 750-4300 Fax (787) 768-2910

As of November 2004

Index

A		F	
AC Adaptor	86, 88	File Number	26, 87, 94
Access Indication	21	Fine	66
AF Mode	67	Fireworks Mode	60
AF/AE Lock	32	Focus	33
Alkaline Batteries	13	Folder Composition	87
Audio Dubbing (DMC-LZ2 only)	77	Folder Number	26, 87, 94
Audio Recording (DMC-LZ2 only)	55, 66	Formatting	82
Auto Bracket	45		
Auto Review	25	H	
Auto White Balance	63	HDTV	65, 84
		Histogram	29
B			
Backlight Compensation	37	I	
Batteries	13	ISO Sensitivity	65
Battery Type	25		
Brightness of the LCD Monitor	25	J	
Built-in Flash	40	Jitter	33
Built-in Memory	20		
Burst Mode	47	L	
		Language setting	27
C		Layout	90
Clock Set	23, 26	LCD Monitor	28, 92
Color Effect	69		
Condensation	4	M	
Copy	81	Macro Mode	54
		Mass Storage	85
D		Motion Image Mode	55
Date Printing	74, 91	Motion Rate	55
Deleting Pictures	52	Multi Playback	50
Demonstration			
of the Optical Image Stabilizer	46	N	
Digital Zoom	68	Night Portrait Mode	60
DPOF Print Setting	73	Night Scenery Mode	59
		Ni-MH Batteries	15
E		Normal Recording	31
Economy Mode	26, 54	NO.RESET	26
Exposure	34	NTSC	26
Exposure Compensation	44	Number of prints	89
		Number of recordable pictures	22

O

Operational sound	26
Optical Image Stabilizer	46
Optical Zoom	39
Oxyride Batteries	13

P

PAL	26
Paper Size	89
Party Mode	61
PC	85, 86
PictBridge	85, 88
Picture Adjustment	69
Picture Mode	35
Picture Size	22, 65
Pictures with Audio (DMC-LZ2 only)	70
Playback	49
Playback Pictures on TV	84
Playback Zoom	51
Playing Back Motion Images	70
Portrait Mode	58
Power Save	25
Protect	75
PTP	85

Q

Quality	66
---------------	----

R

Recording Guide Line	29
Reset of setting	26
Resizing	78
Review	38
Rotate	72
Rotate Display	72

S

Scene Menu	27
Scene Mode	57
Scenery Mode	59
SD Slide Show	77
Self-timer	43
Setup Menu	24
Simple Mode	35
Slide Show	76
Slow Shutter	68
Snow Mode	61
Sports Mode	58
Spot-focusing	67
Standard	66
Status Indicator	14, 18, 54

T

Trimming	79
----------------	----

U

USB Connection Cable	85, 86, 88
USB Mode	26, 85, 86, 88

V

Video output	26, 84
--------------------	--------

W

White Balance	63
White Balance Fine Adjustment	64
White Set	64

Numerics

1-area-focusing	67
3-area-focusing	67
5-area-focusing	67

Spanish Quick Use Guide/Guía rápida en español

Ésta es una visión de conjunto que trata del procedimiento para grabar y reproducir las imágenes con la cámara.

1 Inserte las baterías.

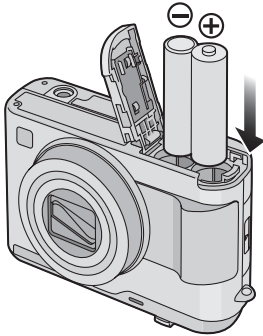

- Si no usa la tarjeta (opcional), puede grabar o reproducir las imágenes en la memoria integrada.

2 Encienda la cámara para tomar las imágenes.

- Ajuste el reloj.
- Seleccione el tipo de batería en uso en [TIPO BAT.] en el menú de [CONF.].

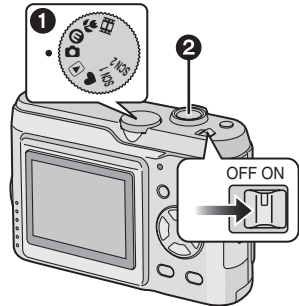

- 1 Ajuste el disco del modo a [P].
- 2 Pulse el botón del obturador para tomar las imágenes.

3 Reproduzca las imágenes.

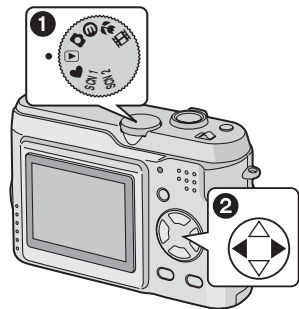

- 1 Ajuste el disco del modo a [R].
- 2 Elija la imagen que quiere ver.

MEMO

MEMO

MEMO



QuickTime and the QuickTime logo are trademarks used under license.
The QuickTime logo is registered in the U.S. and other countries.

**Panasonic Consumer Electronics Company,
Division of Panasonic Corporation of North America**
One Panasonic Way, Secaucus, NJ 07094

Panasonic Puerto Rico, Inc.
Ave. 65 de Infantería, Km. 9.5, San Gabriel Industrial Park, Carolina, Puerto Rico 00985

Panasonic Canada Inc.
5770 Ambler Drive, Mississauga, Ontario, L4W 2T3

© 2005 Matsushita Electric Industrial Co., Ltd.



VQT0P65
F0105Mn0(30000(A)
©

